

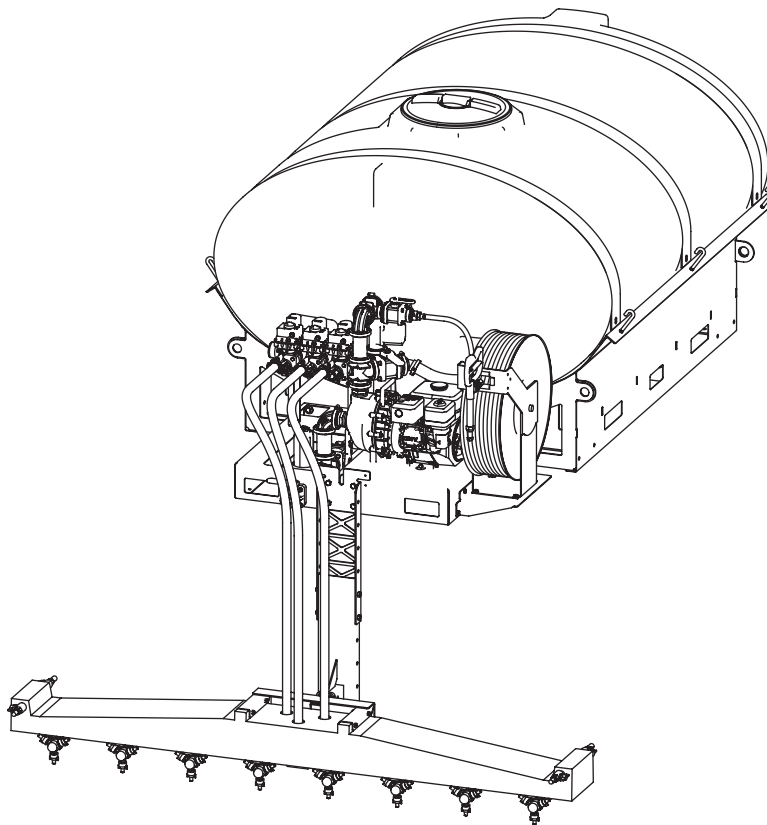

Liqui Maxx™ Sprayer Systems

Owner's Manual and Installation Instructions

Original Instructions



⚠ CAUTION
Read this document before operating
or servicing the equipment.

This manual and instructions are for Liqui Maxx Sprayer Systems
with serial numbers beginning with 160518 and higher.

This document supersedes all editions with an earlier date.

TABLE OF CONTENTS

| | | | |
|--|----|---|----|
| PREFACE | 4 | OPERATING & CALIBRATION INSTRUCTIONS ... | 19 |
| Warranty Registration | 4 | Control Operation | 19 |
| Owner's Information Form | 4 | Deluxe RoadMaster Control | 19 |
| SAFETY | 5 | Standard RC-1B Control..... | 20 |
| Safety Definitions | 5 | RoadMaster Console Functions | 21 |
| Warning/Caution Labels | 5 | Rotary Switch Position Functions..... | 21 |
| Serial Number Label | 6 | Calibration Positions..... | 21 |
| Safety Precautions..... | 6 | Soft Key Functions | 21 |
| Fuses | 7 | Calibration..... | 22 |
| Personal Safety..... | 7 | Entering Calibration Values | 22 |
| Fire and Explosion | 8 | "Special" Calibration | 25 |
| Cell Phones..... | 8 | Entering Calibration Values | 25 |
| Ventilation | 8 | Console Switches & Buttons..... | 29 |
| Battery Safety | 8 | Section Switches | 29 |
| Torque Chart..... | 8 | Resetting System Counters..... | 30 |
| LOADING | 9 | Model RC-1B Standard Sprayer Control..... | 31 |
| Certification..... | 9 | Sprayer Console..... | 31 |
| Specifications..... | 9 | Spray Boom Operation | 31 |
| INSTALLATION INSTRUCTIONS | 10 | Wing Spray Nozzle Selection | 31 |
| Installation and Removal..... | 10 | Downward Spray Nozzle Selection | 32 |
| Control Box Mounting | 12 | Nozzle Alignment | 32 |
| RoadMaster™ Wiring Diagram | 13 | Default Control Settings..... | 32 |
| Installation..... | 14 | Deluxe Control..... | 32 |
| Mounting the Display Console & Switches... | 14 | Application Rates..... | 33 |
| Electrical Installation | 15 | Manual Mode..... | 33 |
| RoadMaster Section Connections..... | 15 | Calculations | 34 |
| Speed Sensor Installation | 16 | Equations..... | 34 |
| RC-1B Installation | 16 | Conversions..... | 34 |
| Wiring Diagram..... | 16 | Example Calculation..... | 35 |
| Battery Connections..... | 16 | MAINTENANCE | 36 |
| FILLING | 17 | Periodic Maintenance | 36 |
| First Time Filling..... | 17 | Cleaning..... | 36 |
| Routine Filling | 17 | End of Season & Storage | 36 |
| Wet Seal Pump..... | 17 | Nozzle Maintenance | 36 |
| Gasoline | 17 | TROUBLESHOOTING | 37 |
| Adding Brine..... | 17 | TROUBLESHOOTING – DELUXE CONTROL | 38 |

PREFACE

This manual has been prepared to acquaint you with the safety information, operation, and maintenance of your new machine. Improper installation and operation could cause personal injury and/or equipment and property damage. Read and understand the Owner's Manual before installing, operating, or making adjustments. Keep this manual accessible.

When service is necessary, call SnowEx® Technical Service at 1-800-SALTERS (725-8377).

NOTE: This unit is designed to be used with salt brine; the use of additives may impact performance.

NOTE: Do not modify or alter the machine. Altering the unit in any way will void the warranty.

The Liqui Maxx™ Sprayer System is designed to apply brine to pre-treat, anti-ice, and post-treat parking lots and roadways. Each Liqui Maxx unit consists of a holding tank, pumping system and control, and a spray boom.

Standard Control – Texas Industrial Remcor Inc

The standard version of the control has the ability to turn the sprayers ON and OFF and increase or decrease the pressure of the system from the cabin.

Deluxe Control – Micro-Trak RoadMaster™

The deluxe version of the control unit has many features that include: push-button controls, application rate adjustment and selection, automatic and manual control modes, visual and audio alarms, and a blast function for spot applications.

A separate GPS unit is offered that incorporates the vehicle speed to automatically adjust the flow rate and maintain the desired application rate. The deluxe control is also compatible with some vehicle speed sensors that can replace the GPS unit. Consult your vehicle owner's manual for more information.

WARRANTY REGISTRATION

Warranty registration is available online at www.snowexproducts.com. Under "Support" click "Warranty Registration" and submit the form online.

OWNER'S INFORMATION

Owner's Name: _____

Date Purchased: _____

Outlet Name: _____ Phone: _____

Outlet Address: _____

Vehicle Model: _____ Year: _____

Equipment Model: _____ Serial #: _____

Length: _____ Weight: _____ lb/kg: _____

RoadMaster™ is a trademark of Micro-Trak Systems, Inc.

SAFETY

SAFETY DEFINITIONS

WARNING

Indicates a potentially hazardous situation that, if not avoided, could result in death or serious personal injury.

CAUTION

Indicates a potentially hazardous situation that, if not avoided, may result in minor or moderate injury. It may also be used to alert against unsafe practices.

NOTE: Indicates a situation or action that can lead to damage to your sprayer and vehicle or other property. Other useful information can also be described.

WARNING/CAUTION LABELS

Become familiar with and inform users about the warning and caution labels on the machine.

If labels are missing or cannot be read, call 1-800-SALTERS (725-8377).

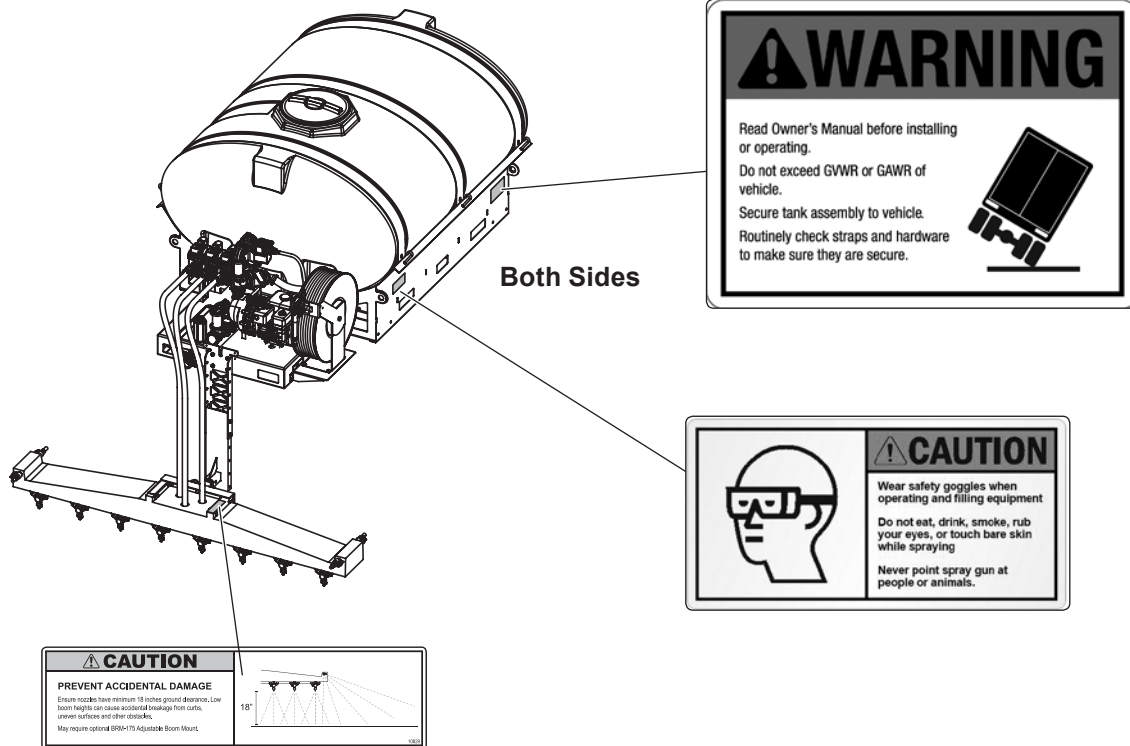

SAFETY

SERIAL NUMBER LABEL

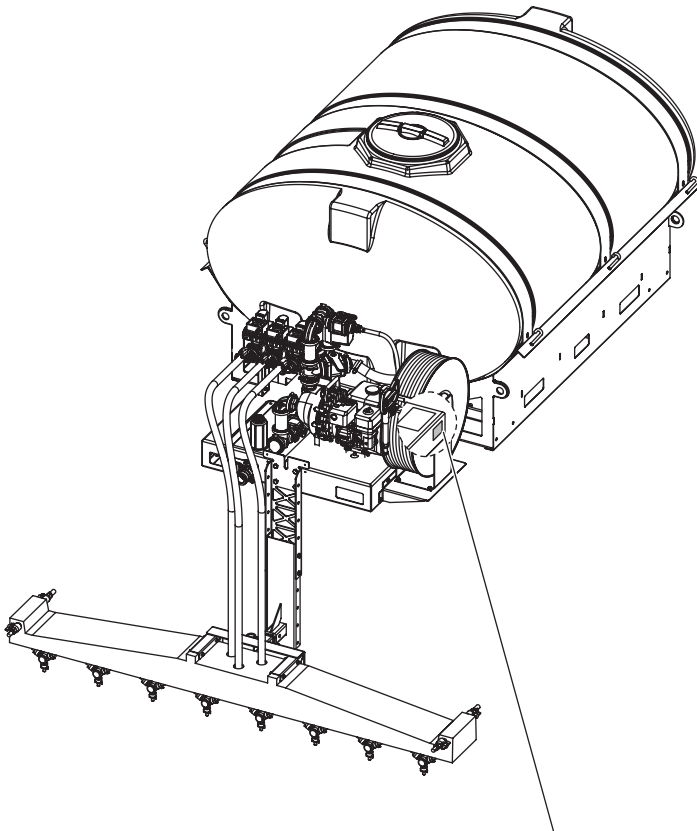



TrynEx International
531 Ajax Drive
Madison Heights, MI 48071
www.snowexproducts.com

XXXXXXXXXXXXXXXXXXXXXXXXXXXX

YYMMDDLXXXZZZZZ



| Code | Definition |
|-------|---------------------------|
| YY | 2-Digit Year |
| MM | 2-Digit Month |
| DD | 2-Digit Day |
| LL | 2-Digit Location Code |
| XXXX | 4-Digit Sequential Number |
| ZZZZZ | Model # |

SAFETY PRECAUTIONS

Improper installation and operation could cause personal injury and/or equipment and property damage. Read and understand labels and the Owner's Manual before installing, operating, or making adjustments.

⚠ WARNING

- Before working with the equipment, secure all loose-fitting clothing and unrestrained hair.
- Before operating the sprayer system, verify that all safety guards are in place.
- Always shut off vehicle before attempting to attach, detach, or service sprayer system.
- Never attempt to take a unit off a truck with liquid in it.
- Do not climb into or ride on the machine.

⚠ WARNING



Overloading could result in an accident or damage. Do not exceed GVWR or GAWR ratings as found on the driver-side vehicle door cornerpost. See Filling section to determine maximum volumes of spraying material.

⚠ WARNING

Securely bolt and strap unit into place on the vehicle bed using the optional UMK-200 bolt kit and ratchet straps or similar. Unit must be strapped down and bolted into position before operating or transporting.

⚠ WARNING

Vehicle handling and characteristics will change with the unit installed. Avoid any sudden steering maneuvers, starts, or stops that could create sloshing and instability.

⚠ WARNING

Always make sure personnel are clear of areas of danger when using equipment. Maintain 60' distance from all bystanders when operating the sprayer system.

SAFETY

⚠ WARNING

Do not install the control for this product in the deployment path of an air bag. Refer to vehicle manufacturer's manual for air bag deployment area(s).

⚠ WARNING

Inspect the unit periodically for defects. Parts that are broken, missing, or worn out must be replaced immediately. Do not alter any part of the unit without prior written permission from the manufacturer.

⚠ CAUTION

Brine is typically a clear to cloudy white liquid with no odor. It may be irritating to the eyes, skin, and respiratory system. For more safety information on brine and other de-icing materials, refer to the manufacturer's Material Safety Data Sheet (MSDS).

⚠ CAUTION

During the sprayer system installation we recommend the addition of an OSHA compliant Backup Alarm. This alarm is required for OSHA governed employers.

⚠ CAUTION

- Do not operate a sprayer system in need of maintenance.
- Before operating the sprayer system, reassemble any parts or hardware removed for cleaning or adjusting.
- Before operating the sprayer system, remove materials such as cleaning rags, brushes, and hand tools from the unit.
- Before operating the sprayer system, read the engine owner's manual, if so equipped.
- While operating the unit, use auxiliary warning lights, except when prohibited by law.
- Tighten all fasteners according to the Torque Chart. Refer to Torque Chart for the recommended torque values.

⚠ CAUTION

Disconnect electric and/or hydraulic power and tag out if required before servicing or performing maintenance.

⚠ CAUTION

Do not leave material in the unit for long periods of time.

NOTE: Lubricate grease fittings after each use. Use a good quality multipurpose grease.

FUSES

The electrical system contains several blade-style automotive fuses. If a problem should occur and fuse replacement is necessary, the replacement fuse must be of the same type and amperage rating as the original. Installing a fuse with a higher rating can damage the system and could start a fire.

PERSONAL SAFETY

- Remove ignition key and put the vehicle in park or in gear to prevent others from starting the vehicle during installation or service.
- Wear only snug-fitting clothing while working on your vehicle or sprayer system.
- Do not wear jewelry or a necktie, and secure long hair.
- Wear safety goggles to protect your eyes from brine, battery acid, gasoline, dirt, and dust.
- Do not eat, drink, smoke, rub your eyes, or touch bare skin while spraying.
- Never point spray gun at people or animals.
- Avoid touching hot surfaces such as the engine, radiator, hoses, and exhaust pipes.
- Always have a fire extinguisher rated BC handy, for flammable liquids and electrical fires.

SAFETY

FIRE AND EXPLOSION

⚠ WARNING

Gasoline is highly flammable and gasoline vapor is explosive. Never smoke while working on vehicle. Keep all open flames away from gasoline tank and lines. Wipe up any spilled gasoline immediately.

Be careful when using gasoline. Do not use gasoline to clean parts. Store only in approved containers away from sources of heat or flame.

CELL PHONES

A driver's first responsibility is the safe operation of the vehicle. The most important thing you can do to prevent a crash is to avoid distractions and pay attention to the road. Wait until it is safe to operate Mobile Communication Equipment such as cell phones, text messaging devices, pagers, or two-way radios.

VENTILATION

⚠ WARNING

Vehicle exhaust contains lethal fumes. Breathing these fumes, even in low concentrations, can cause death. Never operate a vehicle in an enclosed area without venting exhaust to the outside.

BATTERY SAFETY

⚠ CAUTION









Batteries normally produce explosive gases which can cause personal injury. Therefore, do not allow flames, sparks, or lit tobacco to come near the battery. When charging or working near a battery, always cover your face and protect your eyes, and also provide ventilation.

- Batteries contain sulfuric acid, which burns skin, eyes, and clothing.
- Disconnect the battery before removing or replacing any electrical components.

TORQUE CHART

⚠ CAUTION

Read instructions before assembling. Fasteners should be finger tight until instructed to tighten according to the Torque Chart. Use standard methods and practices when installing equipment, including proper personal protective safety equipment.

| Recommended Fastener Torque Chart | | | | | |
|--|---|--|------------|---|--|
| Inch Fasteners Grade 5 and Grade 8 | | | | | |
| Size | Torque (ft-lb) | | Size | Torque (ft-lb) | |
| |  Grade 5 |  Grade 8 | |  Grade 5 |  Grade 8 |
| 1/4-20 | 8.4 | 11.9 | 9/16-12 | 109 | 154 |
| 1/4-28 | 9.7 | 13.7 | 9/16-18 | 121 | 171 |
| 5/16-18 | 17.4 | 24.6 | 5/8-11 | 150 | 212 |
| 5/16-24 | 19.2 | 27.3 | 5/8-18 | 170 | 240 |
| 3/8-16 | 30.8 | 43.6 | 3/4-10 | 269 | 376 |
| 3/8-24 | 35.0 | 49.4 | 3/4-16 | 297 | 420 |
| 7/16-14 | 49.4 | 69.8 | 7/8-9 | 429 | 606 |
| 7/16-20 | 55.2 | 77.9 | 7/8-14 | 474 | 669 |
| 1/2-13 | 75.3 | 106.4 | 1-8 | 644 | 909 |
| 1/2-20 | 85.0 | 120.0 | 1-12 | 704 | 995 |
| Metric Fasteners Class 8.8 and 10.9 | | | | | |
| Size | Torque (ft-lb) | | Size | Torque (ft-lb) | |
| |  Class 8.8 |  Class 10.9 | |  Class 8.8 |  Class 10.9 |
| M6 x 1.00 | 7.7 | 11.1 | M20 x 2.50 | 325 | 450 |
| M8 x 1.25 | 19.5 | 26.9 | M22 x 2.50 | 428 | 613 |
| M10 x 1.50 | 38.5 | 53.3 | M24 x 3.00 | 562 | 778 |
| M12 x 1.75 | 67 | 93 | M27 x 3.00 | 796 | 1139 |
| M14 x 2.00 | 107 | 148 | M30 x 3.50 | 1117 | 1545 |
| M16 x 2.00 | 167 | 231 | M33 x 3.50 | 1468 | 2101 |
| M18 x 2.50 | 222 | 318 | M36 x 4.00 | 1952 | 2701 |
| These torque values apply to fasteners except those noted in the instructions. | | | | | |

LOADING

This Owner's Manual covers vehicles that have been recommended for carrying the sprayer system. Please see your local dealer for proper vehicle applications.

CERTIFICATION

⚠ WARNING

New untitled vehicle installation of a sprayer system requires National Highway Traffic Safety Administration altered vehicle certification labeling. Installer to verify that full sprayer does not exceed GVWR or GAWR rating label and complies with FMVSS.

⚠ WARNING

Overloading could result in an accident or damage. Do not exceed GVWR or GAWR as found on the driver-side cornerpost of vehicle.

⚠ CAUTION



Read and adhere to manufacturer's ice-control material package labeling, including Material Safety Data Sheet requirements.

SPECIFICATIONS

| Liqui Maxx™ Sprayer System | | | | | |
|---|--------|--------------|---------------|---------------|---------------|
| Tank Model | | TSA-300 | TSA-500 | TSA-750 | TSA-1250 |
| Capacity (gal) | | 300 | 500 | 750 | 1250 |
| Tank and Pump Dimensions (in) | Length | 101 | 112 | 118 | 119 |
| | Width | 53 | 59 | 75 | 85 |
| | Height | 24 | 48 | 55 | 73 |
| Empty Unit Weight (lb) | | 500 | 600 | 700 | 1000 |
| Full Unit Weight (lb) | | 3500 | 5600 | 8200 | 13500 |
| Suggested Gross Vehicle Weight Rating (GVWR) (lb) | | 8,500–10,000 | 14,000–16,000 | 16,000–19,500 | 19,500–26,000 |
| Vehicle Class | | Class 2B | Class 4 | Class 5 | Class 6 |

INSTALLATION INSTRUCTIONS

⚠ WARNING



Overloading could result in an accident or damage. Do not exceed GVWR or GAWR ratings as found on the driver-side vehicle door cornerpost. See specifications to determine maximum volumes of spraying material.

⚠ WARNING

New untitled vehicle installation of a sprayer system requires National Highway Traffic Safety Administration altered vehicle certification labeling. Installer to verify that full sprayer does not exceed GVWR or GAWR rating label and complies with FMVSS.

⚠ WARNING

Always shut off vehicle before attempting to attach, detach, or service spray system.

⚠ WARNING

Never attempt to take a unit off a truck with liquid in it.

INSTALLATION AND REMOVAL

NOTE: To prevent leaks, use a thread sealing compound on all threaded connections. Do not use Teflon® tape, as fragments will clog the spray nozzles. Clamped connections may require periodic retightening.

1. Bolt the pump and tank platforms together (6 places).

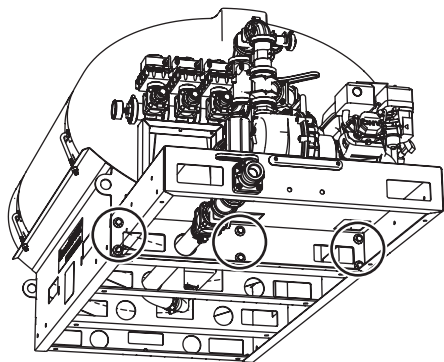

2. Connect the hose underneath the unit: Securely fasten the 90° elbow connection to the tank bulkhead fitting underneath the unit. Make sure the bulkhead fitting is securely fastened to the tank to prevent leaks. Run the 2" hose from the elbow to the shut-off valve below the pump. Clock the 90° elbow so that the hose remains free of kinks; cut it to length. Clamp the hose using two (2) clamps on each end to prevent leaks. In low temperatures, warming the hose may ease installation. Dip the hose in hot water or carefully use a heat gun for 20–40 seconds.

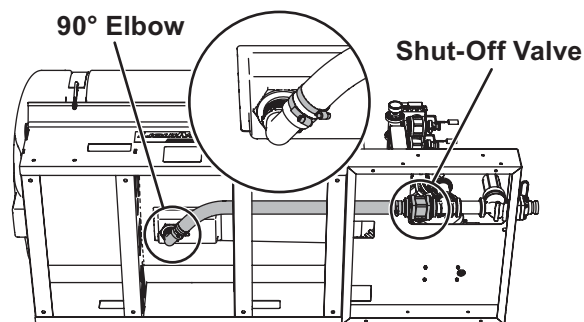

3. Connect the return valve to the 2" bulkhead connection on the pump side of the brine tank. Securely fasten the 45° connections to the tank bulkhead fitting and the return valve. Make sure the bulkhead fitting is securely fastened to the tank to prevent leaks. Clock the 45° connections so that the hose remains free of kinks, and cut the 1-1/2" hose to length. Clamp the hose using two (2) clamps on each end to prevent leaks.

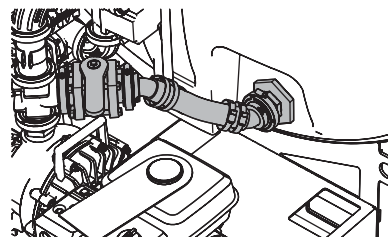

4. Connect the bypass line to the 3/4" bulkhead connection on the pump side of the brine tank. Securely fasten the 90° elbow to the tank bulkhead fitting. Make sure the bulkhead fitting is securely fastened to the tank to prevent leaks. Clock the 90° elbow so that the hose remains free of kinks, and cut the 1/2" hose to length. Clamp the hose tightly to prevent leaks.

Teflon® is a registered trademark of E. I. du Pont de Nemours and Company.

INSTALLATION INSTRUCTIONS

- Lift the main tank and pump assembly using the fork lift pockets. Use caution when inserting forks. Improper insertion may puncture or damage the brine tank and tubing routed underneath the unit. Center the tank and pumping system from driver to passenger side on top of the truck bed and lower into position.

- Install any optional kits and equipment. To install the BRM-175 Adjustable Boom Receiver Mount, unfasten the rear brake light, install the kit, and re-install the light on the top rear face of the BRM bracket.

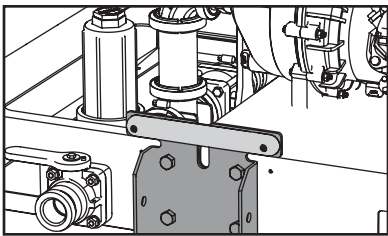

- Securely bolt and strap unit into place on the vehicle bed using the optional UMK-200 Universal Mounting Kit or similar brackets and ratchet straps. Hardware attaching the sprayer system directly to the vehicle is the responsibility of the end user.

NOTE: Pay special attention when drilling or clamping dissimilar metals to aluminum bodies. Galvanic corrosion can occur if not handled properly. Contact vehicle manufacturer for recommended attachment practices.

- Measure the distance between front of the truck bed and the tank base. Make a spacer to fill between the tank base and the front of the truck bed. Failure to install this spacer could result in damage to the sprayer and/or vehicle.

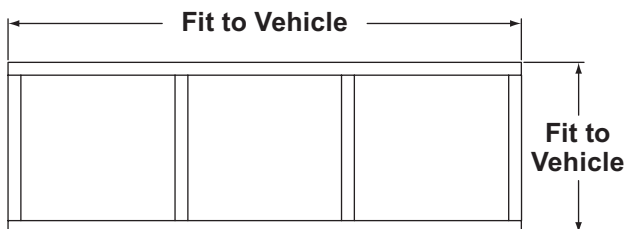

⚠ CAUTION

Ensure nozzles have minimum 18 inches ground clearance. Low boom heights can cause accidental breakage from curbs, uneven surfaces, and other obstacles. Adjustment may require optional BRM-175 Adjustable Boom Mount.

- Install the boom so the nozzles measure 18"–22" from ground to nozzle tip. This is to prevent damage and ensure optimal performance. Consider using the optional BRM-175 Adjustable Boom Receiver Mount if the tips of the nozzles lie outside this zone when using your stock receiver hitch.

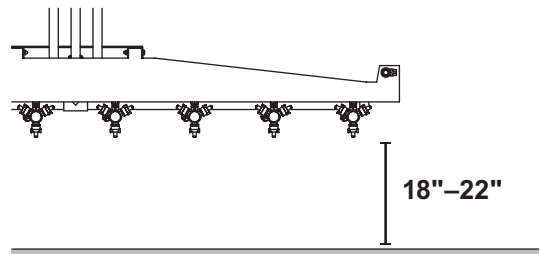

- Connect the boom to the pump. Clamp the quick disconnect attachments on the boom hoses to the manifold valves on the pumping unit. Route the hoses to the installed boom with adequate slack and cut the hoses to fit. Clamp the hose tightly to the boom to prevent leaks.

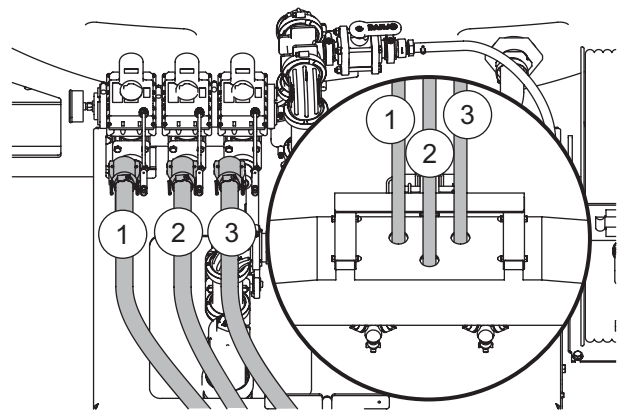

- Fill the pump's antifreeze reservoir with a mixture of 50% ethylene-glycol and 50% water. The seal should be completely submerged. Check mixture every 8 hours of operation and each time the gasoline tank is filled. See filling instructions.

INSTALLATION INSTRUCTIONS

CONTROL BOX MOUNTING

NOTE: Use dielectric grease to prevent corrosion on all connections.

Before beginning the installation, remove all battery cables from the vehicle battery terminals.

1. Route the control box harness along the vehicle frame. Do not route it close to the exhaust system or engine, where extreme heat could melt the wiring insulation and short out the sprayer and vehicle electrical systems. Attach the harness to frame holes and frame supports. Do not attach to fuel or brake lines. Use heavy duty cable ties or frame clamps to fasten the harness along the frame.
2. Lay out the control power cable along the fire wall and fender well. **Do not connect the power leads to the battery yet.**

⚠ CAUTION

Before drilling holes, check to see that no vehicle wiring or other components could be damaged.

3. Route the control power cable and harness using an existing access hole through the fire wall into the vehicle cab. If adding an access hole is necessary, check the area on the other side of the fire wall to make sure you will not drill into vehicle wiring or other components.

⚠ WARNING

Do not install the control for this product in the deployment path of an air bag. Refer to vehicle manufacturer's manual for air bag deployment area(s).

⚠ CAUTION

Do not mount the control close to any heater vents or in areas prohibited by the vehicle manufacturer for crashworthiness. See the vehicles body builder's book, owner's manual, or service manual for details.

⚠ CAUTION

Do not alter, modify, or install component in shaded areas shown below. Failure to comply may interfere with airbag deployment or cause injury to operator in an accident.

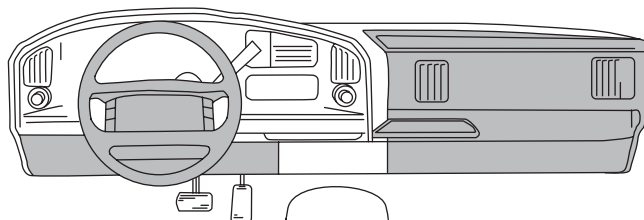

4. Connect the harness and the control power cable to the back of the control and mount the control in a suitable location within easy reach of the vehicle operator without restricting access to the vehicle controls and instruments.
5. Connect the harness to the battery. Refer to the wiring diagrams for battery connections.

INSTALLATION INSTRUCTIONS

RoadMaster™ WIRING DIAGRAM

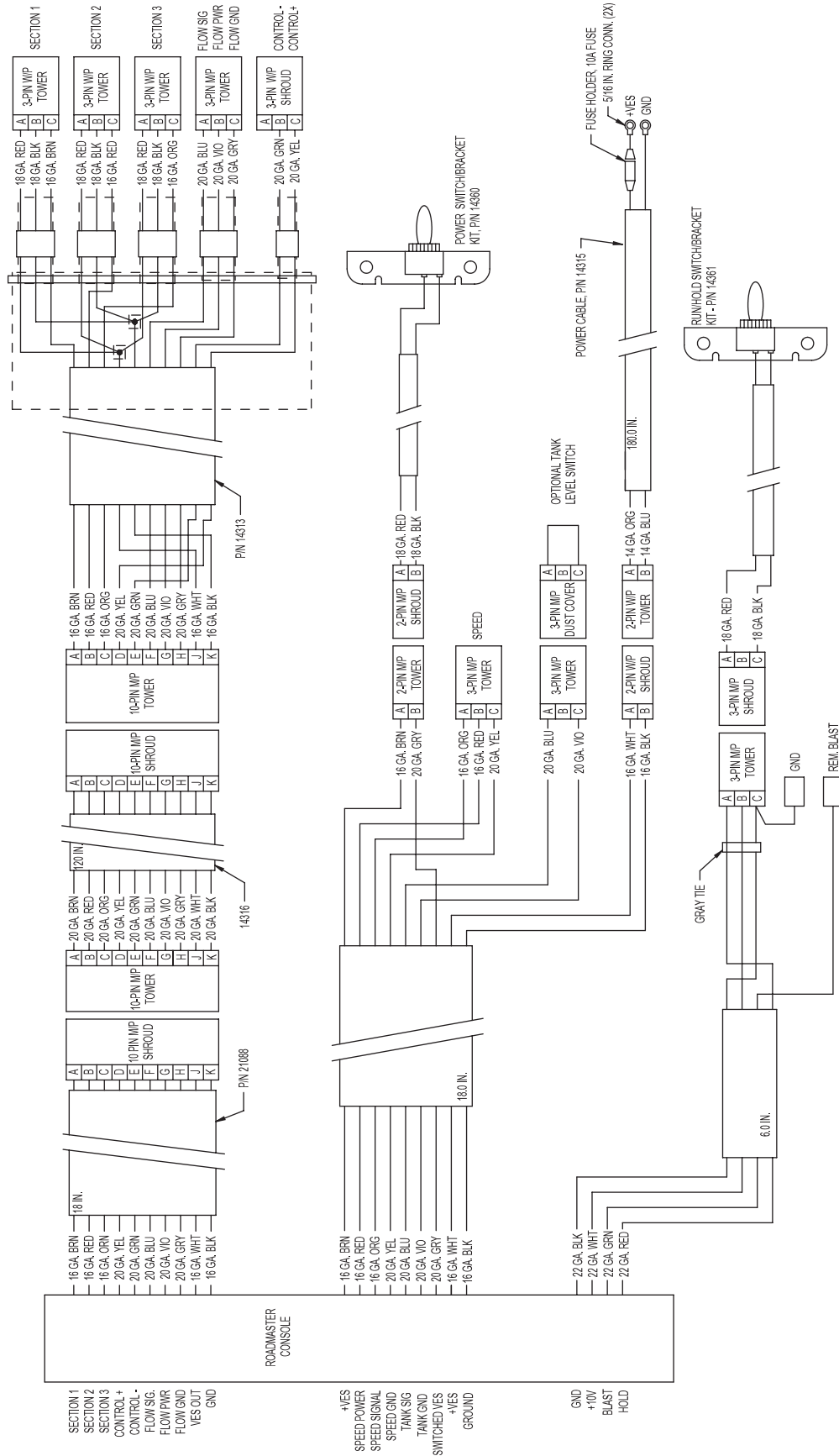

RoadMaster™ is a trademark of Micro-Trak Systems, Inc.

INSTALLATION INSTRUCTIONS

INSTALLATION

Mounting the Display Console & Switches

Select a mounting location that is convenient to reach and highly visible to the operator. Do not install in a position that obstructs the view of the road or work area. Whenever possible, avoid locations that expose the console to direct sunlight, high temperature, strong chemicals, or rain.

Place the mounting bracket in the selected location, mark holes, drill 1/4" (7 mm) holes and mount bracket with bolts, lock washers, and nuts provided. (Use self-tapping screws if not practical to use bolts.)

See Illustration 1.

Put rubber washers on carriage bolts and put the bolts through the bracket holes from the inside out. Place console over carriage bolt heads.

Install the switch brackets over the carriage bolts and alongside the console bracket. Install the mount knobs on the carriage bolts and tighten to secure the console and switch brackets in place.

See Illustrations 2 & 3.

Install the switches in the brackets, making sure that the "ON" position is oriented up. Attach the quick disconnects on the switch harnesses to the switches (see wiring diagram). Then install the switch harness connectors into the mating connectors on the console harness. Typically the power ON/OFF switch is mounted on the left and the RUN/HOLD switch is mounted on the right.

Console Mount Kit

Illustration 1

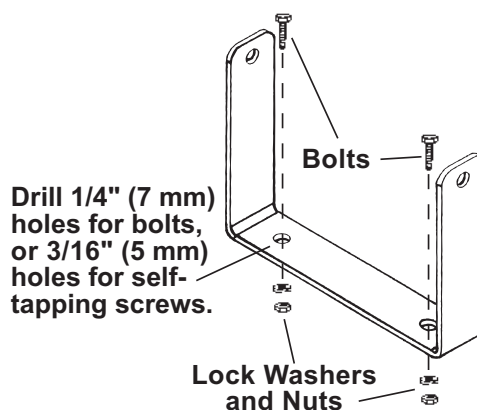

Console ON/OFF Switch

Illustration 2

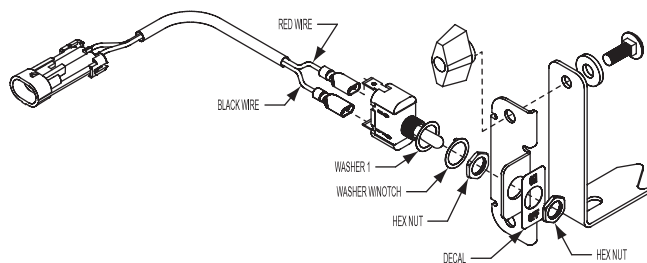

Console RUN/HOLD Switch

Illustration 3

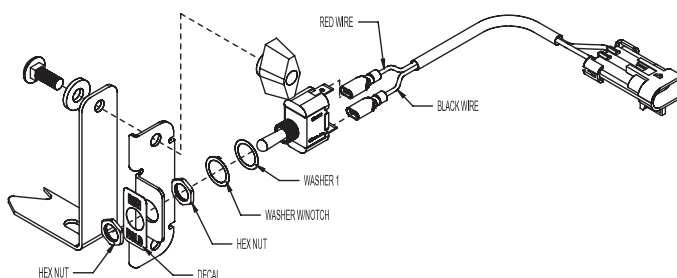

INSTALLATION INSTRUCTIONS

INSTALLATION (CONT.)

Electrical Installation

NOTE: The RoadMaster™ must be connected to a 12-volt DC negative ground electrical system.

Power/Battery Connection

Locate the power cable for the RoadMaster and route to the battery. When routing cable to console, avoid areas where the cable may be subject to abrasion or excessive heat. Attach the BLUE wire (ground) to a screw or bolt on the equipment frame. **See Illustration.** Be sure there is clean metal-to-metal contact. Connect the ORANGE wire to the positive battery terminal.

Connect the power to the RoadMaster console by plugging the 2-pin W/P tower on the power cable into the 2-pin W/P shroud of the display console.

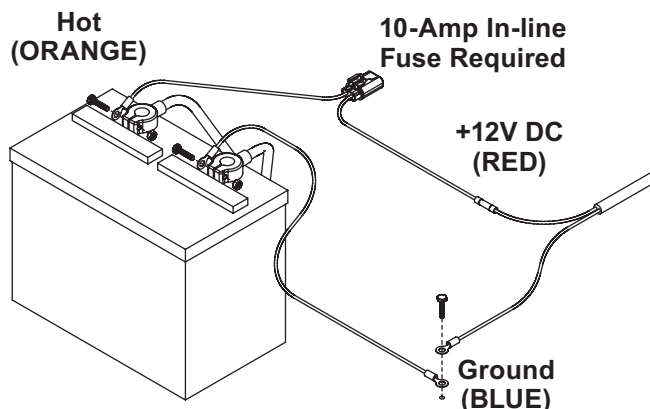

RoadMaster Section Connections

Section Shut-off Valves

Locate labeled section valve connectors 10' Flow/Control/Section Harness. Connect these connectors to corresponding valves. Apply silicone grease to valve connections to avoid corrosion.

NOTE: When using the system in LANE MODE, Section 2 defines the Lane Width. If only using one section valve, connect the Section 2 connector to it and use the Section 2 (center) switch on the console to control it.

10' Flow/Control/Section Harness Wiring

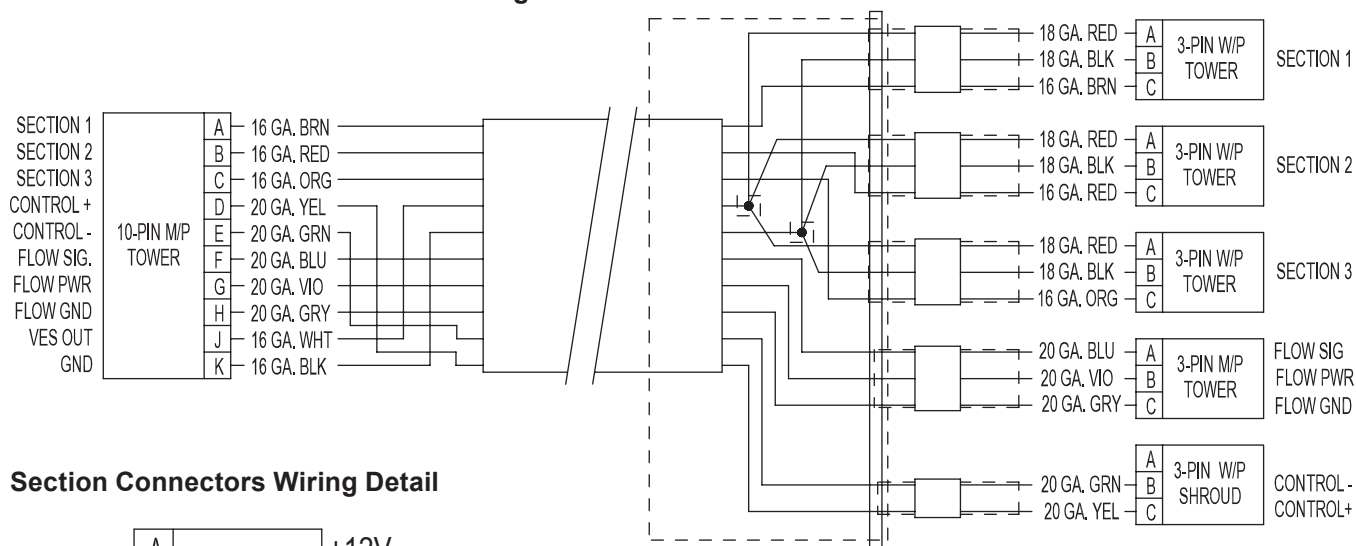

Section Connectors Wiring Detail



INSTALLATION INSTRUCTIONS

INSTALLATION (CONT.)

Speed Sensor Installation

Installation Note: The harness provides local connection for the speed sensor. For speed sensor installations on implements, add 3-pin extension cables as required.

Astro 5 GPS Speed Sensor



Please Note: If you have purchased an Astro GPS Speed Sensor, a Vansco radar or other radar or GPS speed sensor, install the Astro, the Vansco, or other radar as described in the instructions included with the unit.

Speed Sensor Options

In addition to the standard Hall-effect magnetic speed sensor, the RoadMaster™ may be interfaced with a variety of other speed sensing equipment. Several options are listed below.

Astro Series or Other GPS Speed Sensor Interfaces

The RoadMaster may also be used with most GPS speed sensors that output a pulsed signal, such as the Micro-Trak Astro 5, SkyTrak or Dickey-John GPS speed sensors. An adapter cable may be required.

Installing External BLAST Switch

An optional external **Momentary ON** BLAST switch can be connected to the two quick-connect terminals provided on the harness (**see Wiring Diagram**). The remote BLAST switch allows the operator to control the BLAST function from a switch mounted on an armrest or other convenient location.

RC-1B INSTALLATION

Wiring Diagram

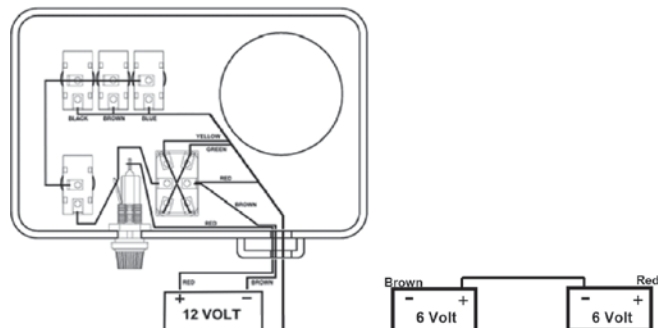

Battery Connections

Important – Attach the red wire to the – post. The electrical system must be 12 Volt. If the tractor has two 6 Volt batteries, the red wire must be attached to the + post on the battery that has the power cable to the tractor electrical system. The brown wire can be attached to the – post on the other battery or anywhere on the tractor frame. See wiring diagram.

FILLING

⚠ WARNING

Overloading could result in an accident or damage. Do not exceed GVWR or GAWR as found on the driver-side cornerpost of vehicle.

⚠ WARNING

Always shut off vehicle before attempting to attach, detach, or service spray system.

⚠ CAUTION

Starting the motor with no antifreeze will damage the seal in the pump. Check antifreeze levels before starting.

Refer to the specifications section to determine sprayer weights and capacities.

FIRST TIME FILLING

1. Install the sprayer and any optional equipment. See the installation section of this manual for details.
2. Install or attach any other equipment that will be on the vehicle while the sprayer will be in use (step bumper, trailer hitch, snowplows, etc.) and fill gas tanks.
3. Obtain the Gross Vehicle Weight Rating (GVWR), Front Gross Axle Weight Rating (FGAWR), and Rear Gross Axle Weight Rating (RGAWR) from the certification label typically located inside the driver-side door.
4. With the occupants in the truck for normal sprayer operation, weigh the vehicle to obtain gross vehicle weight (GVW).
5. Subtract the GVW from the GVWR to determine the available material payload. For reference, brine weighs approximately 10 lb/gal. For more weight information see the specifications section of this manual or the material manufacturer's specifications.

ROUTINE FILLING

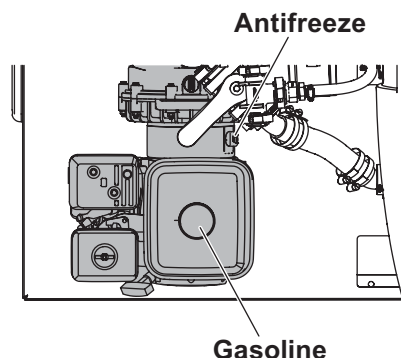

Wet Seal Pump

Fill the pump's antifreeze reservoir with a mixture of 50% ethylene-glycol and 50% water. Check mixture every 8 hours of operation and when the gasoline tank is filled. The reservoir should be at least 75% full, with the seal completely submerged. See diagram.

Gasoline

Fill the motor with gasoline as needed.

Adding Brine

Fill the brine tank to the desired level using the steps below. Use the markings on the tank for volume reference. If filling is slow, check the intake filter. For more info see the maintenance and troubleshooting sections of this manual.

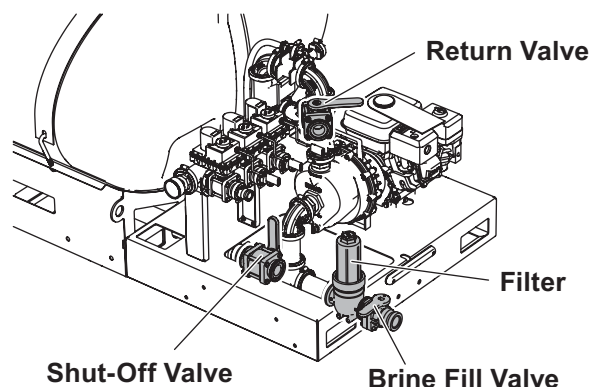

FILLING

Filling with an external pump

1. Connect fill hose to the brine fill valve. (Opening the valves first will cause standing brine in the tank to flow out.)
2. Once hose is hooked up, open the brine fill and shut-off valves.
3. Once the valves are open, begin pumping brine from the holding tank using the external pump.
4. Fill to the desired level.
5. Close the brine fill valve. The shut-off valve must be open for spraying.

Filling with the Liqui Maxx™ sprayer's pump

NOTE: This method only works when the brine reservoir level is above the tank level. The pump requires a gravity-fed start to remove standing air in the piping. Once the pump is primed it will function normally.

1. Connect fill hose to the brine intake valve. Opening the valve first will cause standing brine in the mixing tank to flow out.
2. Once the hose is hooked up, open the brine fill and return valves, and close the shut-off valve.
3. Once brine begins to flow in, start the motor.
4. Fill tank to desired level.
5. Close the brine fill and return valves and open the shut-off valve.

OPERATING AND CALIBRATION INSTRUCTIONS

⚠ WARNING

Always make sure personnel are clear of areas of danger when using equipment. Maintain 60' distance from all bystanders when operating the spray system.

⚠ WARNING

Vehicle handling and characteristics will change with the unit installed. Avoid any sudden steering maneuvers, starts, or stops that could create sloshing and instability.

⚠ WARNING

Before operating the sprayer, verify that all safety guards are in place.

⚠ WARNING

Unit must be strapped down and locked into position before operating or transporting.

⚠ CAUTION

Starting the motor with no antifreeze will damage the seal in the pump. Check antifreeze levels before starting.

CONTROL OPERATION

Deluxe RoadMaster™ Control

Follow the steps below to get started using your deluxe control. Complete details and instructions follow in this section.

1. Before spraying, consider what speed range you wish to operate in and select and install the appropriate nozzles using the application rate charts in this manual. Note that the unit will not function as intended outside these ranges.
2. Turn the power switch ON. The unit will display the software version and the total hours of operation for 1.5 seconds each. Be sure the control is set to HOLD or the boom switches are set to OFF before starting the Liqui Maxx™ sprayer's motor to prevent unintentional spraying.

The RUN/HOLD button is the master switch to turn all sections ON and OFF. For example, instead of using the individual section switches, simply use the RUN/HOLD switch.

3. Set the valves to the spray configuration. Start the Liqui Maxx sprayer's motor by turning the motor ON, setting the appropriate choke, and pulling the recoil start handle.

Spray configuration:

- Brine Fill Valve: Closed
- Shut-off Valve: Open

4. Select the spray mode by pressing the AUTO/MAN button on the bottom left of the control until the desired mode is displayed on the top right of the control display. Select Automatic Mode if you wish to have the control automatically hold a target application rate and your unit has a compatible speed sensor installed. If you are doing driveways or other applications where it is difficult to stay within a target speed range, it may be desirable to use Manual Mode. If speeds of 4–6 mph are desired, Manual Mode is recommended.

Automatic Mode

1. During normal operation, set the rotary switch to RATE to see the actual application rate per acre. The unit will automatically adjust to the target application rate which can be seen and adjusted using the Up (+) and Down (-) arrow buttons on the control. Use the RUN/HOLD button and the boom switches to control the boom as desired. The factory defaults below can be adjusted as desired. See "Entering Calibration Values" in this section.

Factory Defaults:

- Target Application Rate: 30
- Rate Increment: ± 5
- Units: Gallons/Acre

The Automatic Mode has a BLAST function intended for spot application that requires a higher application rate like bridges or intersections. This can be changed to any value and it is not associated with the standard application rate. See "Entering Calibration Values" in this section.

OPERATING AND CALIBRATION INSTRUCTIONS

Factory Defaults:

- Blast Target Rate: 35
- Blast Duration: 5 seconds
- Units: Gallons/Acre

The control is also equipped with visual and audio alarms. The alarms will trigger if the actual application rate is above or below 10% of the target rate. For more information on the alarms and other control features see "RoadMaster™ Console Functions" in this section.

2. To avoid draining the vehicle battery, turn the control OFF when not in use.
3. When finished turn the motor OFF.

NOTE: The unit cannot automatically adjust the application rate unless there is a compatible speed sensor installed.

Manual Mode

NOTE: In this mode the control will not compensate for speed.

1. During normal operation, set the rotary switch to VOLUME/MINUTE to see the flow rate. This value can be adjusted using the Up (+) and Down (-) arrow buttons on the control. Use the RUN/HOLD button and the boom switches to control the boom as desired.

Factory Defaults

- Units: Gallons/Acre

2. To avoid draining the vehicle battery, turn OFF the control when not in use.
3. When finished turn the motor OFF.

Standard RC-1B Control

Follow the steps below to get started using your standard control. See the RC-1B Owner's Operating Manual for complete details and instructions.

1. Before spraying, consider what speed range you wish to operate in and select and install the appropriate nozzles using the application rates charts in this manual. Note that the unit will not function as intended outside these ranges.
2. Set the master switch to OFF and turn the power switch ON.
3. Set the valves to the spray configuration. Start the Liqui Maxx™ sprayer's motor by turning the motor ON, setting the appropriate choke, and pulling the recoil start handle.

Spray Configuration:

- Brine Fill Valve: Closed
- Shut-off Valve: Open
- Return Valve: Set pressure to 40 psi by opening and adjusting return valve.

4. During normal operation, use the master switch and boom switches to control the boom as desired. Increase or decrease the pressure of the system as desired using the pressure switch.
5. To avoid draining the vehicle battery, turn OFF the control when not in use.
6. When finished turn the motor OFF.

OPERATING AND CALIBRATION INSTRUCTIONS

RoadMaster™ CONSOLE FUNCTIONS

The RoadMaster features a large, easy-to-read liquid crystal display, rotary dial, and lighted panel for night use.

Rotary Switch Position Functions

KEYLOCK FUNCTION – When locked allows the user to view calibration values but prevents changes, allows Data Set 1 to be cleared but prevents clearing Data Sets 2 & 3 (Volume, Area, Distance, Average & Highest Velocity).

TANK ALARM – Can be initiated by either the optional Tank Level Switch or the Tank Counter (if Tank Alarm is set in "Special" Calibration).

REMOTE BLAST SWITCH - Optional: The Optional Remote Blast Switch can initiate the BLAST sequence in normal operation, the same as the console BLAST switch.

AUDIBLE ALARM: Alarm will sound for Rate errors over 10%, Tank Level below set point or Tank Empty (from Float input). The alarm can be temporarily shutoff by setting rotary switch to MODE (Alarm Reset) and pressing the RESET button. **Note: Setting ALARM ENABLE to OFF in "Special" Calibration will disable All Audible Alarms.**

VOLUME (1) (2) (3): Displays total gallons (liters) of liquid applied. May be reset. SEE NOTE

VOLUME/MINUTE: Displays total gallons (liters) of liquid applied per minute.

TANK LEVEL: Displays gallons (liters) of liquid remaining. If a FILL TANK SIZE has been set to a value in Calibration, pressing the "+" will make the Tank value jump to FILL TANK SIZE value. The value can be decreased but not increased above the FILL size. If the FILL TANK SIZE is set to Zero, Tank level can be adjusted to any value from 0 to 65,535 using the "+" or "-" (RESET) keys.

RATE: Displays application rate.

WARNING LIGHT: Indicates over- or under-application of plus or minus 10% from the Target Rate or if the tank is low or minimum flow active. Also lit when in CAL and Unlocked.

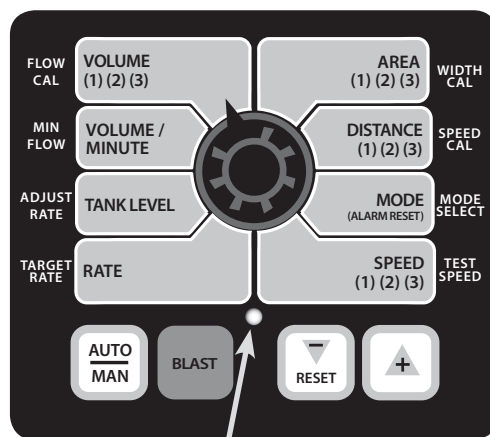

AREA (1) (2) (3): Keeps a running count of the total area worked. May be reset. SEE NOTE

DISTANCE (1) (2) (3): Displays distance traveled. May be reset. SEE NOTE

MODE: Displays selected mode. User selects between Lane, Ag, Dust, and Turf Modes of operation. Allows Audible Alarm to be RESET by Pressing the RESET button.

SPEED (1) (2) (3): Displays ground speed in miles per hour (kilometers per hour) or Average & Highest velocity. May be reset. SEE NOTE

NOTE: VOLUME, AREA, DISTANCE, & SPEED counters work in sets. If the VOLUME counter 1 is reset, it also resets AREA counter 1, DISTANCE counter 1 and Average & Highest Speed counter 1. This will be the same for resetting any counters in the set.

Calibration Positions

FLOW CAL: Enter the calibration value assigned to your flowmeter (see flowmeter tag).

MIN FLOW: Enter the minimum flow rate of the application system.

ADJUST RATE: Enter an amount of change for on-the-go adjustments to the target rate.

TARGET RATE: Enter the target application rate.

Calibration Positions

WIDTH CAL: Enter the working width.

SPEED CAL: Enter the speed calibration number in inches (cm) per pulse.

MODE SELECT: Allows the user to change the MODE SELECT between modes of operation. Lane, Ag, Dust, and Turf.

TEST SPEED: Simulates ground speed for system checkout.

Soft Key Functions



Key which changes operation from automatic control to manual. (If Manual Control is enabled, see page 21.)

BLAST

Multi-function key:

- Used to enter and exit the calibration and "special" calibration modes.
 - Used to initiate BLAST sequence in normal operations.
 - Overrides flowmeter input in case of an Emergency Stop.
 - Toggles between SPEED CAL and Distance traveled while fine tuning the SPEED CAL factor or between FLOW CAL and Volume when fine tuning the Flow Cal factor.
- See Appendices C & D.**



PROGRAM KEYS: In normal operating modes, used to increase/decrease application rate. With Rotary Switch in the SPEED position, RESET key

is used to display Average and Maximum Speed. In Volume, Area, Distance, or Speed, the "+" key selects counter set.

- RESET: When in HOLD and not in CAL, clears the selected counter **set** when held for two seconds. When rotary switch is in the MODE position, Resets Audible Alarm.
- When in CAL, the "+" key increases and the "-" decreases the calibration value displayed.

OPERATING AND CALIBRATION INSTRUCTIONS

CALIBRATION

Entering Calibration Values

To enter or change any of the system's calibration values, you must enter calibration.

NOTE: UNITS (English or Metric) must be set in "Special" Calibrate before any other CALIBRATE or "SPECIAL" CALIBRATE values.

Calibration Procedure:

1. Turn the sections OFF or put the system in HOLD.
2. Hold the BLAST key for 1 second. The CAL icon will be visible and calibration values can be viewed and edited.
3. Select calibration position with rotary selector. Calibration positions are identified by the WHITE labeling on each side of the rotary selector.
4. Edit calibration values by using the "+" and "-" buttons on the front panel. Switch between calibration positions as needed. (See CALIBRATION SEQUENCE section for recommended sequence)
5. Hold BLAST key for 1 second to save changes and exit calibration mode. The CAL icon will disappear and operations can resume. If you do not wish to save your changes, reboot console without pressing BLAST – original values will return.

If the Console is *unlocked*, the Warning LED will also turn ON and any of the CALIBRATE values can be adjusted.

If the Console is *locked*, the Warning LED will not turn ON and the CALIBRATE (except TEST SPEED) values can only be viewed and cannot be adjusted. TEST SPEED is active whether locked or unlocked.

Illustration 6

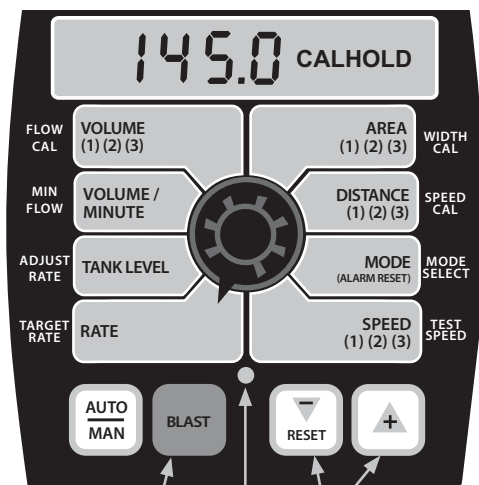

Press to enter or exit calibration mode.

Press to increase or decrease values.

Red warning light will be lit when in CAL and unlocked.

CALIBRATION SEQUENCE

Once in calibration mode, you may change any one, all, or none of the values, in any order, but it is very important to set **MODE first**. MODE SELECT defines the unit of measurement for all system calculations.

Note: TEST SPEED is NOT a calibration setting. It simulates vehicle speed during Pre-Application System Checkout. This procedure is described on page 26.

MODE SELECT: MODE SELECT allows the user to change the MODE. Pressing the "+" or "-" (reset) will toggle between Lane, Ag, Dust and Turf (except in Metric) MODE and the display will show LANe, Ag, dUSt and turF.

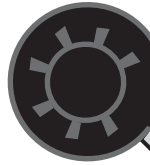

DEFINITIONS OF LANE, AG, DUST AND TURF MODES:

LANE: Used for Highway Maintenance Applications where Area is accumulated in Units of Lane Miles (Lane Km). Distance is in Units of Miles (Km) and Application Rate is in amount of liquid per Lane Mile (Lane Km).

AGRICULTURAL: Mainly used for roadside spraying, where Area is in acres (hectares), Distance is in feet (meters) and Application Rates are in Gallons/Acre (liters/meter²).

DUST CONTROL: Used for controlling suspended particulates, where Area is in square yards (square meters), Distance is in yards (meters) and Application Rates are in Gallons/Yard² (liters/meter²).

TURF (English Only): Where Area is in 1000 square feet, Distance is in feet and Application Rates are in Gallons/1000 feet².

NOTE: A Mode change CLEARS the counters if Calibration is exited correctly. If power to the console is turned OFF before exiting Calibration, the counters are NOT cleared.

TARGET RATE: Selecting TARGET RATE (in English) displays the desired application rate in these units:

LANE mode - Gallons per Lane Mile

AG mode - Gallons per Acre

DUST mode - Gallons per Sq. Yard

TURF mode - Gallons per 1000 Sq. Feet

Selecting TARGET

RATE (in Metric) displays the desired

application rate in

Liters/Lane Km for LANE mode, Liters/Hectare for AG

Mode and Liters/Meters² for DUST mode. TURF mode

does not apply to Metric settings. This is the application

rate that the console will lock onto when operating in

AUTO. The Warning LED will flash and Audible Alarm will

sound if enabled whenever the actual application rate is

more than 10% from TARGET RATE.



OPERATING AND CALIBRATION INSTRUCTIONS

CALIBRATION (CONT.)

Entering Calibration Values (cont.)

ADJUST RATE: In AUTO control with RATE selected, pressing "+" or "-" will change the TARGET RATE by the amount entered for ADJUST RATE.

This allows the operator to make changes to the TARGET RATE

quickly. To disable this feature, simply enter "0" for a value.



MIN FLOW: The purpose of this calibration setting is to prevent the system from applying below the recommended minimum flow rate for the nozzles.

Enter the minimum flow rate in gallons per minute (liters per minute) based

on the nozzles being used, for the entire section width of the applicator. DO NOT enter the target flow of your spray application. For example: If the minimum flow rate for the nozzle you are using is .22 GPM at their minimum recommended pressure and your section has 20 nozzles, enter 4.4 as the MIN FLOW value (.22 x 20 = 4.4). The system WILL NOT apply at a rate lower than this value when spraying in AUTO. The Warning LED will FLASH whenever the system is applying at Minimum Flow Rate but the Audible Alarm will not sound. This value should be checked/changed for each different nozzle that you use.

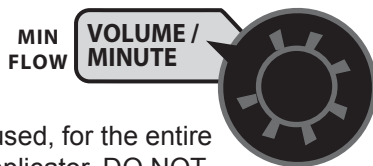

FLOW CAL: This position is used to calibrate the flow meter for accurate liquid measurement. Enter the Micro-Trak liquid cal number printed on the flowmeter tag

(See Illustration 7) The Flow Cal number should not be changed during operation because a change in the Flow Cal number will also change some counter values.

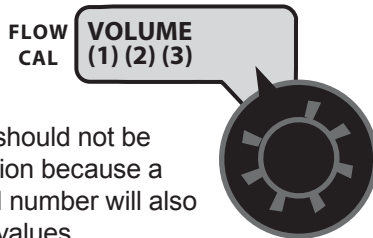
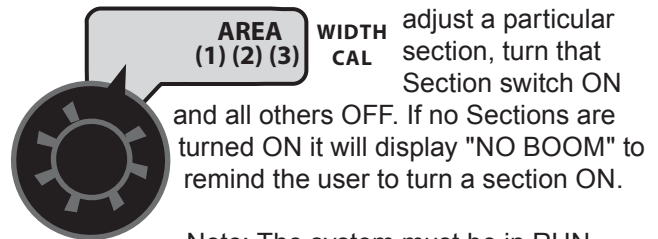

Illustration 7



NOTE: Your RoadMaster™ flowmeter has been tested at the factory and assigned a "FLOW CAL" value to make it operate properly with the RoadMaster™ console. This number is printed on the white plastic tag attached to the flowmeter. See Illustration 7. In the illustration example, the liquid calibration number is "148". This is a starting point only. If your spray solution has a specific gravity or viscosity that is different than water, flowmeter calibration should be done for the specific solution (please refer to Fine-Tuning Flowmeter Calibration in Appendix D on page 36.)

WIDTH CAL: Displays the Section WIDTH in inches for the Section selected (Unused Section must be set to zero). The total width (sum of all Section widths) must not exceed 65,535 inches or 65.535 meters. To



adjust a particular section, turn that Section switch ON and all others OFF. If no Sections are turned ON it will display "NO BOOM" to remind the user to turn a section ON.

Note: The system must be in RUN to display section numbers. Repeat this procedure for each section. Enter a value of "0" (.000) for any unused sections. Your "working" width per section will be the number of nozzles on the section times the nozzle spacing in inches (meters). For example, if you have 7 nozzles spaced at 20 inches, the working width of the section is 140 inches.

NOTE: RoadMaster™ consoles are equipped with 3 Section switches. In Lane Mode the CENTER Section switch is always the PRIMARY Section and is used to define the "LANE WIDTH". Ag, Dust or Turf Modes can use any Section switch. If the operator is only using ONE Section it must be the Primary Section.

CAUTION: If spray lines are pressurized, nozzles may spray during WIDTH calibration (below).

NOTE: When in Lane Mode, a Lane Mile/kilometer is defined as the area in a swath equal to the Center (Primary) Section width, that is one (1) mile/km long. The user defines a Lane Mile/kilometer by changing the Center Section width. For example, if the Center (Primary) Section Width is set to 12 feet, and the Left and Right Sections are set to three feet, one mile traveled will result in an Area of 1.5 Lane Miles covered.

OPERATING AND CALIBRATION INSTRUCTIONS

CALIBRATION (CONT.)

Entering Calibration Values (cont.)

SPEED CAL: This position is used to calibrate the speed sensor for accurate speed and distance measurement. When this position is selected, the display will show the SPEED CAL value along with "CAL" on the display. In English units, the SPEED CAL number is displayed in inches, in metric it is displayed in centimeters. The SPEED CAL is factory-calibrated for use with an Astro GPS Speed Sensor. See the table below for SPEED CAL numbers for other types of GPS speed sensor or radars. **See Appendix B for procedure to calibrate if using a Magnetic Speed Sensor. See Appendix C for Fine-Tuning Speed Calibration.**

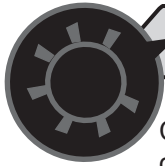

DISTANCE
(1) (2) (3)

SPEED
CAL

TEST SPEED: Choose the value to be used for simulating speed for performing Pre-application System checkout. The console will use this speed for simulating spraying operations. The test speed value is only used while in calibration mode. Once CAL is exited, the Test Speed value is reset to zero.

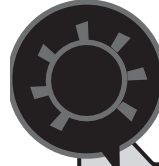

SPEED
(1) (2) (3)

TEST
SPEED

Please refer to Pre-application System Checkout on page 26 for details.

EXITING CALIBRATION: Upon completion of the calibration process, exit calibration. Basic calibration is now complete. Please refer to Pre-application System Checkout section to confirm overall system performance.

OPERATING AND CALIBRATION INSTRUCTIONS

"SPECIAL" CALIBRATION

Entering Calibration Values

NOTE: UNITS (English or Metric) must be set in "Special" Calibrate before any other CALIBRATE or "SPECIAL" CALIBRATE values.

There are three (3) pages of "SPECIAL" CALIBRATE values, total of 18 used for Standard Drive, selected by the rotary switch and BLAST key. To enter Special Cal, put the system in HOLD, turn the console power OFF, press and hold the BLAST button while turning console ON. The console will display SPEC for 2 seconds to show that the console is in the Special Calibration mode. Release the BLAST button.

If the Console is unlocked, the Warning LED will also turn ON and any of the "Special" CALIBRATE values can be adjusted.

If the Console is locked, the Warning LED will not turn ON and the "Special" CALIBRATE values can only be viewed and cannot be adjusted.

NOTE: Press and release the BLAST key to alternate between SPECIAL CAL pages 1, 2, and 3 (Number icons indicate page).

The desired Special Calibration Parameter(s) can then be accessed with the rotary switch. To exit Special Calibration, press and hold the BLAST button for 1 second. The console will save any changes and revert to normal operation.

To exit without saving changes, simply turn the console power OFF without pressing BLAST.

Special Calibration

| Special Cal Page 3 | Special Cal Page 2 | Special Cal Page 1 |
|--------------------|---------------------|----------------------|
| Manual Enable | Minimum Alarm Speed | Fill Tank Size |
| | Start Time | Tank Alarm Set Point |
| | Auto Shutoff | Blast Duration |
| Alarm Enable | Auto Delay Time | Blast Target Rate |

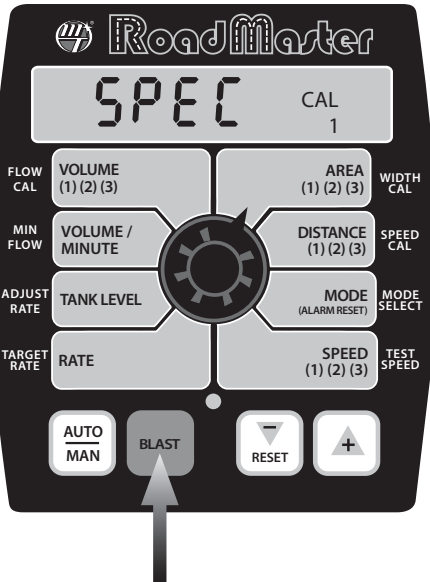

| Special Cal Page 1 | Special Cal Page 2 | Special Cal Page 3 |
|--------------------|--------------------|--------------------|
| Units (Eng/Metric) | Set Year | |
| Vehicle Number | Set Month | |
| Valve Polarity | Set Date | |
| Valve Speed | Set Time | |

OPERATING AND CALIBRATION INSTRUCTIONS

"SPECIAL" CALIBRATION (CONT.)

Entering Calibration Values (cont.)

Page One

NOTE: Changing UNITS will load defaults, so they should always be changed first and then all other CALIBRATE and "SPECIAL" CALIBRATE values may be set.

UNITS (English or Metric):

AREA (1) (2) (3) **WIDTH CAL** Selecting the AREA position on page one (1) allows the user to change the UNITS and load defaults. Pressing the "+" or "-" (RESET) keys will toggle between English and Metric UNITS and the display will show En9 or nEt. **NOTE:** Trying to select Metric Units in Turf Mode will cause the Error message to be displayed. Defaults will not be loaded until the Rotary Selector is moved away from AREA or the "Special" Cal page is changed or "Special" Cal is exited normally.

VEHICLE NUMBER:

DISTANCE (1) (2) (3) **SPEED CAL** Selecting the DISTANCE position on page one (1) allows the user to change the VEHICLE NUMBER from 0 to 255 by using the "+" or "-" (Reset) keys. The VEHICLE NUMBER is downloaded with the Total and Configuration data through the serial port.

VALVE POLARITY:

MODE (ALARM RESET) **MODE SELECT** Selecting MODE position on page one (1) allows the operator to install the flow control valve in either a By-Pass or In-Line configuration. Pressing the "+" or "-" (reset) key will toggle the display between bYPAS and InLin.

VALVE SPEED: Selecting the SPEED position on page one (1) allows VALVE SPEED to be changed, to adjust system response speed (if required). Pressing the "+" or "-" (Reset) keys will adjust the VALVE SPEED from -4 to 3.

SPEED (1) (2) (3) **TEST SPEED** Normal setting is -1. **NOTE: Use caution when adjusting the Valve Speed setting. Higher values used with a fast valve may cause system instability (hunting, oscillations).**

BLAST TARGET RATE:

Selecting the RATE position on page one (1) allows the user to enter the desired BLAST TARGET RATE. The units and range are identical to the normal TARGET RATE but BLAST TARGET RATE is only used when the **BLAST** key is pressed.

TARGET RATE **RATE**

BLAST DURATION:

Selecting the TANK LEVEL position on page one (1) allows the user to enter the desired BLAST DURATION. It can be adjusted from 0 (OFF) to 255 seconds.

ADJUST RATE **TANK LEVEL**

TANK ALARM SET POINT:

Selecting the VOLUME/MINUTE position on page one (1) allows a TANK ALARM SET POINT to be entered. When enabled, the Warning LED flashes, the alarm sounds and the display alternates between FILL and normal when Tank volume falls below the Set Point. When set to "OFF", the alarm is disabled.

MIN FLOW **VOLUME / MINUTE**

FILL TANK SIZE: Selecting the VOLUME position on page one (1) allows the user to enter a

FLOW CAL **VOLUME (1) (2) (3)** FILL TANK SIZE which can be toggled to OFF or 1 to 65535 using the "+" or "-" (reset) keys. The FILL TANK SIZE is in gallons in English or liters if in Metric Units. If a FILL TANK SIZE is specified, then pressing "+" while set to the **TANK** position (in Operation) will set the TANK value to FILL TANK SIZE for quick reloading.

OPERATING AND CALIBRATION INSTRUCTIONS

"SPECIAL" CALIBRATION (CONT.)

Entering Calibration Values (cont.)

Page Two

MINIMUM ALARM SPEED: Selecting the VOLUME position on page two (2)

allows adjustment of the MINIMUM ALARM SPEED. Pressing the "+" or "-" (Reset) keys will adjust the MINIMUM ALARM SPEED from 0.1 to 99.9 mph or km/h. When the ground speed is below the MINIMUM ALARM SPEED, an Application Rate error will not generate an Audible Alarm. Tank empty and Float alarms are not disabled. Setting the MINIMUM ALARM SPEED to OFF will disable the function and allow audible warnings at any speed. This setting can be used to disable nuisance alarms while stopping and starting.

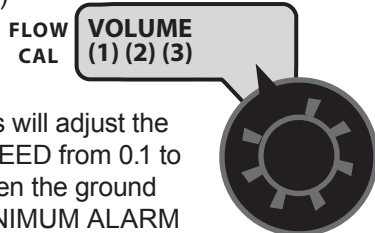

START TIME: Selecting the VOLUME/MINUTE position on page two (2) allows the user to change the START TIME for the control valve. The START TIME can be adjusted from OFF to 2.048 seconds. The START TIME runs the Control Valve towards open for the amount of time (seconds) set, when a HOLD to RUN transition occurs. The control valve may be used to stop hydraulic flow and can be the cause of an undesirable delay for the Servo to return to normal operating flow. The START TIME cal value can be used to reduce this delay.

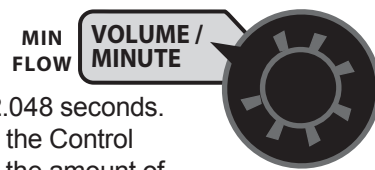

AUTO SHUT OFF: Selecting the TANK LEVEL position on page two (2) allows the user to turn the AUTO SHUT OFF feature ON or OFF by using the "+" or "-" (Reset) keys. While in AUTO with the AUTO SHUT OFF turned OFF automatic control will "freeze" the current flow when HOLD is pressed. With the AUTO SHUT OFF ON, the servo valve will run towards closed for 4 seconds each time HOLD is selected or ground speed is stopped. This is useful for stopping flow when using auger or belt delivery systems.



AUTO DELAY TIME: Used to delay adjustment of the servo valve (in AUTO) until section or ON/OFF valves have completely opened. Selecting the RATE position on page two (2) allows the user to change the AUTO DELAY TIME by using the "+" or "-" (Reset) keys to vary the delay time from 0 (no delay) to 1, 2, 3 or 4 seconds.

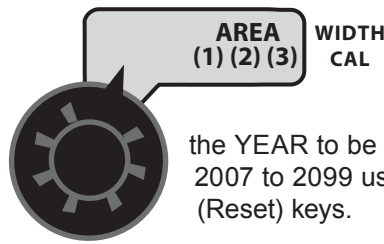
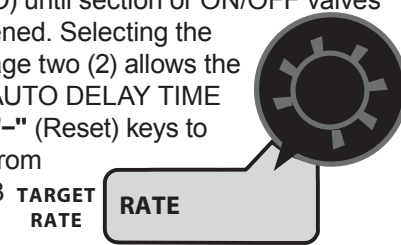

SET YEAR: Selecting the AREA position on page two (2) allows the YEAR to be set from 07 to 99 for 2007 to 2099 using the "+" or "-" (Reset) keys.

SET MONTH: Selecting the DISTANCE position on page two (2) allows the MONTH to be set from 01 to 12 (Jan to Dec) by using the "+" or "-" (Reset) keys.

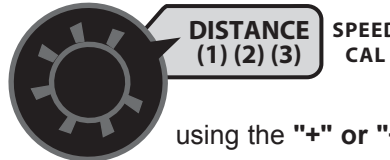

SET DATE: Selecting the MODE position on page two (2) allows the DATE to be set from 01 to 31 by using the "+" or "-" (Reset) keys.

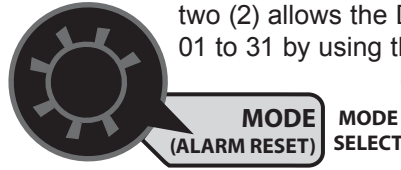

SET TIME: Selecting the SPEED position on page two (2) allows the user to change the TIME from 00:00 to 23:59 by using the "+" or "-" (Reset) keys. The LCD does not include a colon so a decimal point is used.

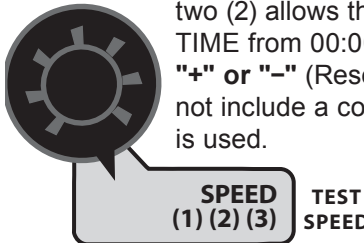

OPERATING AND CALIBRATION INSTRUCTIONS

"SPECIAL" CALIBRATION (CONT.)

Entering Calibration Values (cont.)

Page Three

MANUAL ENABLE: Selecting the VOLUME position on page three (3) allows the user to turn the MANUAL CONTROL ENABLE ON or OFF by using "+" or "-" (Reset) keys. Setting to OFF disables Manual Control. Pressing the AUTO/MANUAL key will not toggle between Auto and manual when set to ON.

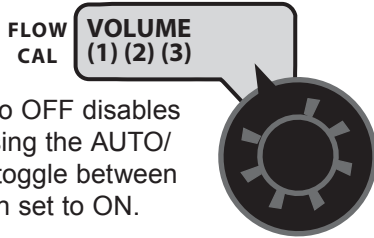

ALARM ENABLE: Selecting the RATE position on page three (3) allows the user to turn the audible ALARM ENABLE ON or OFF by using the "+" or "-" (Reset) keys. Setting ALARM ENABLE to OFF will disable all audible Alarms under all conditions.

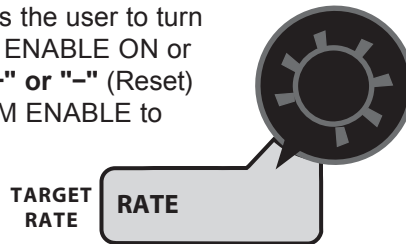

OPERATING AND CALIBRATION INSTRUCTIONS

OPERATION (CONT.)

Console Switches & Buttons (cont.)

SECTION SWITCHES

The system monitors the status of the section switches to determine whether they are ON or OFF. The console accumulates area based on the calibrated section widths. When an individual section is turned OFF, the respective width is subtracted from the total width to accumulate area based on the new active application width. If the rotary switch is in the RATE position, the numbers 1, 2, or 3 on the display will light when their respective section is ON.

NOTE: Most RoadMaster™ consoles are equipped with 3 Section switches. In Lane Mode the CENTER Section switch is always the PRIMARY Section and is used to define the "LANE WIDTH". Ag, Dust or Turf Modes can use any Section switch. If the operator is only using ONE Section it must be the Primary Section.

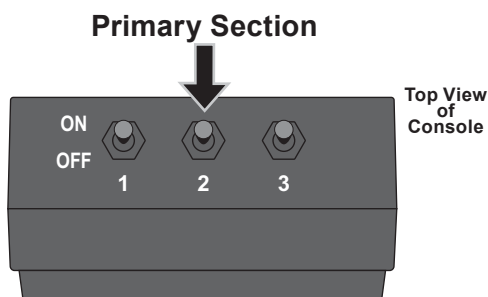

Warning Device

The console is equipped with a RED warning light. The light will automatically turn ON and flash when the actual application is plus or minus 10 percent of the calibrated target rate, or if the TANK alarm feature is activated and the tank is below the set point (display will also flash "FILL" message). If the light stays ON while in AUTO, refer to the troubleshooting section of this manual. The RED warning light will also be illuminated when calibration mode is active on the console.

Audible Alarm

The Audible Alarm is activated for the following conditions:

1. The Tank Level is below minimum level (TANK ALARM SET POINT).
2. Float switch is continuously active for 15 seconds or more.
3. The application Rate Error is greater than 10% for 3 seconds (continuously) after the Auto Delay and Start Up time have completed and the console is in AUTO, and the Ground Speed is above the Alarm Minimum Speed.

Emergency Stop

When in AUTO and in RUN with one or more Sections ON and the Speed is greater than zero, if the Flow signal ever stops, the servo will run to fully open. If Flow remains stopped for 5 seconds or more, it will automatically reduce the flow to a minimum (run Servo closed for 4 seconds). "EStOP" will then display to notify the user of the Emergency Stop. The flow remains off (or reduced) and AUTO control will remain disabled until the system goes into HOLD, power is cycled or CALIBRATE is entered. The Emergency Stop feature helps protect against "chemical spills" or over-application if the Flow signal is lost.

NOTE: Volume, Area, DISTANCE & SPEED counters work in sets, if the VOLUME counter 1 is reset, it also resets AREA counter 1, DISTANCE counter 1 and SPEED counter 1. This will be the same for resetting any counters in the set. Do Not use the "-" button to select counters because the button will clear them. (See Resetting System Counters on page 25). The active set of counters may be reset to zero independent of other sets of system counters.

Serial Port

The DB-9 connector on the back of the console provides access for serial communication. The serial configuration is RS-232, 9600 baud, in 8-N-1 half-duplex format. Data is sent and received in comma-delimited ASCII format. An external device (GPS/Mapping/AVL System) can change the application rate on-the-go and also receives and records data from the RoadMaster. **See Appendix H and I for data lists available.**

OPERATING AND CALIBRATION INSTRUCTIONS

OPERATION (CONT.)

Resetting System Counters

The VOLUME, AREA, DISTANCE & SPEED data counters maintain a running count during operation regardless of the position of the rotary switch. When any of these counters reach their maximum capacity, or when you want to start a new count, the value may be reset to zero by performing the following routine. Counter sets may be reset independently of each other.

NOTE: If the console is locked, only Data Set 1 can be cleared.

1. Turn the sections OFF or put the system in HOLD.
2. Turn the rotary switch to Volume, Area or Distance.
3. There are three independent VOLUME counters, paired with three AREA counters, paired with three DISTANCE counters and with three SPEED Values (Average and Highest velocity). The active set of counters is indicated by the small numbers in the lower right area of the display (1, 2, or 3) when the rotary switch is in the VOLUME, AREA or DISTANCE position. Select the set of counters you want to RESET by pressing the "+" button. The small number will increment each time the "+" button is pressed (from 1 to 3, then rolls back to 1). DO NOT attempt to select the counter number by using the "-" button, because that will clear the active set of counters if held for 2 seconds. If the "-" button is accidentally pressed, the console will display "CLEAR" to alert the user that the counters will be cleared. If the user continues to hold the "-" button for 2 seconds "CLEAR" will disappear and be replaced by 0.0, indicating that the selected set of counters has been cleared.

Display indicates that counter set #1 is selected

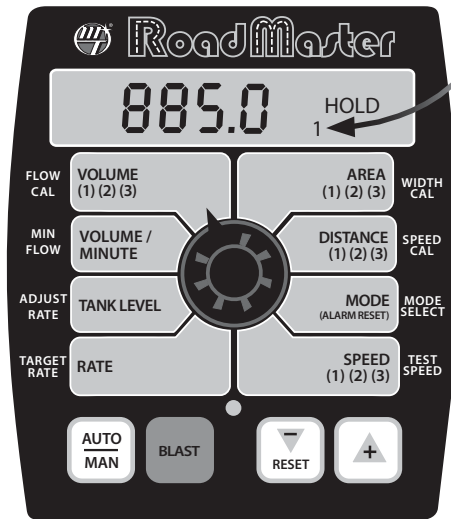

Display indicates that counter set #2 is selected

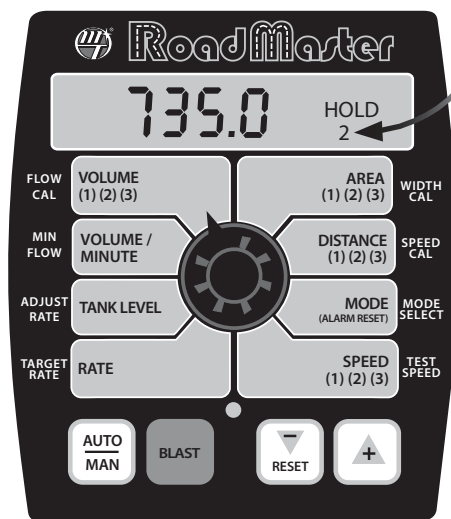

Display indicates that counter set #3 is selected

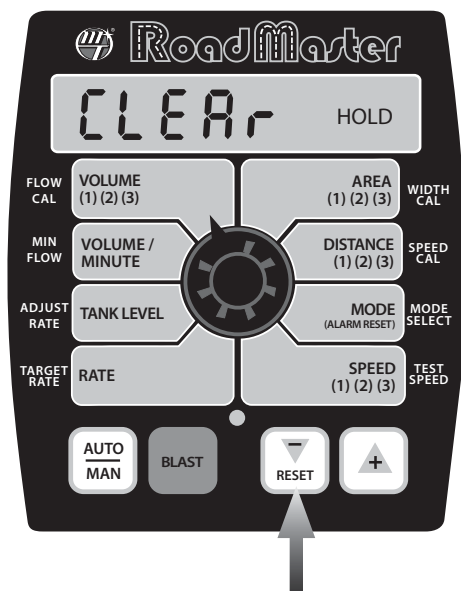
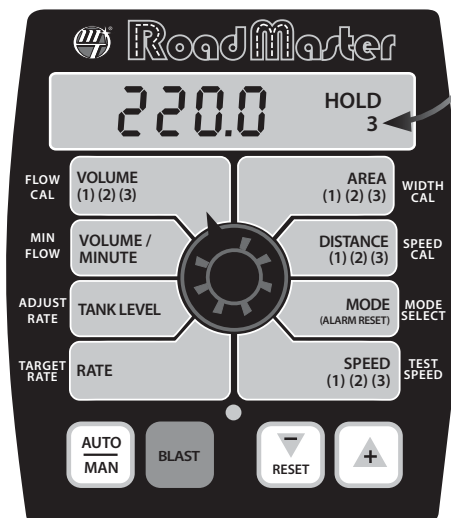

OPERATING AND CALIBRATION INSTRUCTIONS

MODEL RC-1B STANDARD SPRAYER CONTROL

Sprayer Console

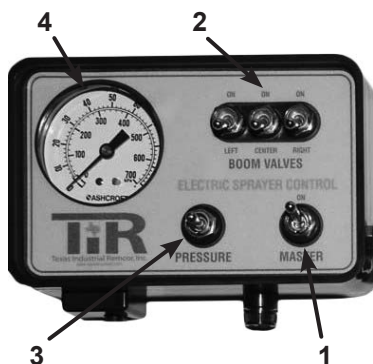

1. **Master Switch** – Switches power to the boom switches. Always use this switch to cut off the entire boom.
2. **Boom Switches** – Three ON/OFF switches for individual boom sections. (Two, four, or five switches optional.)
3. **Regulator Switch** – Forwards or reverses the regulator motor, which raises or lowers the spraying pressure. Small pressure changes can be made by jogging the switch up or down.
4. **Pressure Gauge** – It is recommended that the tubing to the pressure gauge be connected to the center of the boom.

Find a convenient place to mount the console. Use the holes in the mounting bracket as a template to drill holes for the mounting screws.

The RC-1B Remote Control System provides the freedom of mounting the control valves anywhere on the sprayer. This can eliminate long boom, pressure, and bypass hoses.

Quick disconnects permit permanent installation of the valve assembly on the sprayer and the control box in the tractor cab.

SPRAY BOOM OPERATION

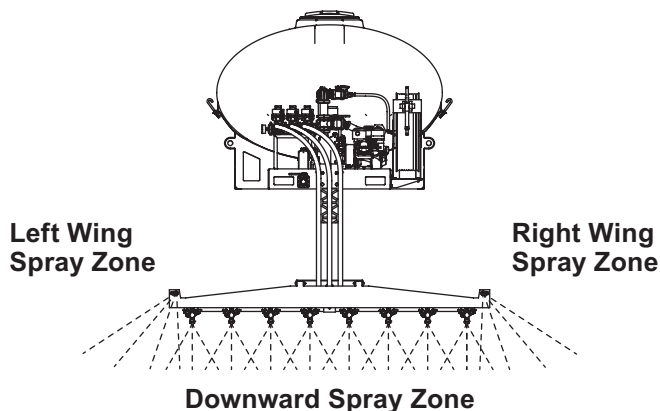

Wing Spray Nozzle Selection

Select the nozzles to use by referring to the application rates charts. Open the desired nozzles on the wing by turning the valve handle so that it is parallel to the nozzle. Close the nozzles not being used by turning the valve handle perpendicular to the nozzle.

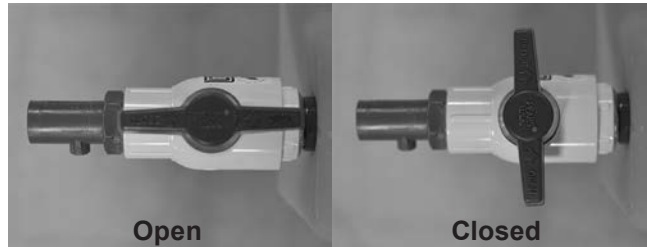

In some cases it is beneficial to increase or decrease the distance covered by the wing nozzles by rotating the nozzle(s) on the wing. Note that this will also affect the application rate for the spray zone. For details on how the distance affects the application rate of the nozzles, see "Calculations" in this section.

OPERATING AND CALIBRATION INSTRUCTIONS

Downward Spray Nozzle Selection PBA-300

Select the nozzles to use by referring to the application rates charts. Rotate the selection wheels so that the desired nozzle faces downward.



Nozzle Alignment

For consistent brine application, make sure the holes in the nozzles are aligned with the boom.

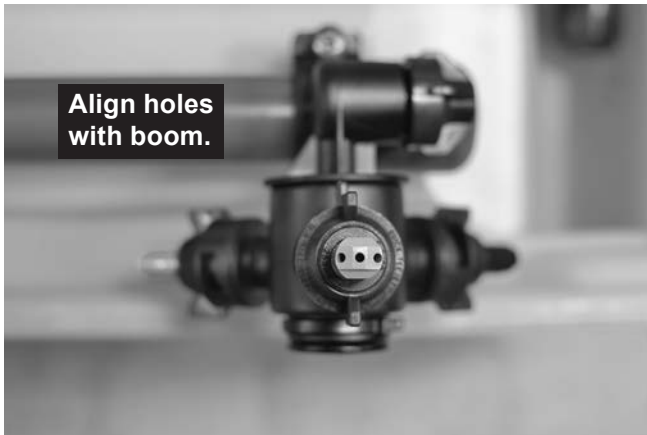

DEFAULT CONTROL SETTINGS

Deluxe Control

The values for the deluxe control unit below have been factory calibrated for the Liqui Maxx™ Sprayer System and can be changed at any time through typical control calibration procedures. For more information on how to calibrate the control, refer to the RoadMaster™ Reference Manual.

| Factory Settings — Deluxe Control | |
|-----------------------------------|---------|
| | ENGLISH |
| Tank Set Point | OFF |
| Fill Tank Size | OFF |
| Control Speed | -1 |
| Vehicle Number | 1 |
| Blast Target Rate | 35 |
| Blast Duration | 5 |
| Start Time | 0(OFF) |
| Auto Delay Time | 1 sec |
| Valve Polarity | Bypass |
| Auto Shut-off | ON |
| Minimum Alarm Speed | 0 MPH |
| Manual Control Enable | ON |
| Alarm Enable | ON |
| Default Calibration Values | English |
| Mode | Acres |
| Speed Cal | 0.189 |
| Flow Cal | 148 |
| Min Flow | 0.0 |
| Target Rate | 30.0 |
| Adjust Rate | 5.0 |
| Section 1 Width | 96.0 |
| Section 2 Width | 96.0 |
| Section 3 Width | 96.0 |

OPERATING AND CALIBRATION INSTRUCTIONS

APPLICATION RATES

Application rates are to be selected and adjusted by the user according to ground conditions and temperatures. Initial market research suggests an application rate of approximately 30 gallons/acre for use in de-icing and anti-icing. Application rates in the charts below are based on manufacturer's numbers. If your flow is uncharacteristically slow, see the troubleshooting and maintenance section.

Nozzle Selection

Suggested Operating Range 30–40 psi

| Boom Nozzle† | Width (ft) | gal/min @30psi‡ | Total gal/min† | gal/min @40psi‡ | Total gal/min† |
|-------------------------|------------|-----------------|----------------|-----------------|----------------|
| Brown (<i>std</i>) | 8 | 0.38 | 3.0 | 0.42 | 3.4 |
| Gray (<i>acc</i>) | 8 | 0.45 | 3.6 | 0.50 | 4.0 |
| White (<i>std</i>) | 8 | 0.61 | 4.9 | 0.67 | 5.4 |
| Lt Blue (<i>acc</i>) | 8 | 0.76 | 6.1 | 0.84 | 6.7 |
| Lt Green (<i>std</i>) | 8 | 1.04 | 8.3 | 1.26 | 10.1 |
| Black (<i>acc</i>) | 8 | 1.47 | 11.8 | 1.68 | 13.4 |

| Side Nozzle† | Width (ft) | gal/min @30psi‡ | Total gal/min† | gal/min @40psi‡ | Total gal/min† |
|----------------------|------------|-----------------|----------------|-----------------|----------------|
| Red (<i>std</i>) | 8 | 0.37 | 3.0 | 0.42 | 3.4 |
| White (<i>std</i>) | 8 | 0.72 | 5.8 | 0.84 | 6.7 |

† Application calculations assume boom set @ 18" from ground

‡ Application calculations adjusted with a factor of specific gravity for brine solution of 1.189

Manual Mode Standard & Deluxe Control

Use the charts below to select the appropriate nozzles for your route when using the standard control or the manual mode on the deluxe control. These values are approximations based on manufacturer's data and should be replaced with actual tested values whenever possible.

Suggested Nozzle Configuration

| Desired Speed (mph) | Center Nozzles | Boom Nozzles | Gallons Per Acre | Gallons Per Lane Mile |
|---------------------|----------------|--------------|------------------|-----------------------|
| 5–7 | Brown | Red | 25–40 | 35–60 |
| 8–11 | White | White | | |
| 12–20 | Green | Red & White | | |

Application Rate Table

| Desired Application Rate* | Gallons Per Acre | Gallons Per Lane Mile |
|---------------------------|------------------|-----------------------|
| 50 | 22 | 32 |
| 60 | 26 | 38 |
| 70 | 31 | 44 |
| 80 | 35 | 51 |
| 90 | 39 | 57 |

* lb of NaCl Active Ingredient Per Acre @ 23.3% Solution

OPERATING AND CALIBRATION INSTRUCTIONS

CALCULATIONS

| Nozzle Flow Rates (gal/min) | | | |
|-----------------------------|------|-----|----------------|
| Wing Nozzles | Min | Max | Center Nozzles |
| Red | 2.9 | 4 | |
| White | 5.2 | 8 | Blue |
| Red & White | 7.9 | 12 | Green |
| | 11.3 | 16 | Black |

Equations

$$S \left(\frac{\text{Miles}}{\text{Hour}} \right) = G \left(\frac{\text{Gallons}}{\text{Minute}} \right) \times \left(\frac{1}{A \left(\frac{\text{Gallons}}{\text{Acre}} \right)} \right) \times \left(\frac{1}{B \text{ (8 Feet*)}} \right) \times \left\{ \frac{60 \text{ Minutes}}{1 \text{ Hour}} \times \frac{1 \text{ Mile}}{5280 \text{ Feet}} \times \frac{43560 \text{ Square Feet}}{1 \text{ Acre}} \right\}$$

$$S \left(\frac{\text{Miles}}{\text{Hour}} \right) = G \left(\frac{\text{Gallons}}{\text{Minute}} \right) \times \left(\frac{1}{A \left(\frac{\text{Gallons}}{\text{Lane Mile}} \right)} \right) \times \left(\frac{1}{B \text{ (8 Feet*)}} \right) \times \left\{ \frac{60 \text{ Minutes}}{1 \text{ Hour}} \times \frac{1 \text{ Mile}}{5280 \text{ Feet}} \times \frac{63360 \text{ Square Feet}}{1 \text{ Lane Mile}} \right\}$$

A = Application rate in gallons per acre or gallons per lane mile

S = speed in miles per hour

G = flow rate of the nozzles in gal/min (See chart above for min and max values)

B = Spray width in feet (* 8 feet is the default width)

Conversions

1 lane mile = 1.45 acres

1 acre = 43560 square feet

1 lane mile = 63360 square feet

OPERATING AND CALIBRATION INSTRUCTIONS

Example Calculation

What is the fastest I can travel if both the wing nozzles are adjusted to cover 5 feet instead of 8 feet, with an application rate of 30 gallons per acre? (Note that the boom application rate will not change.)

Using the equation to solve for speed, the variables are as follows:

S_{max} = Unknown

A = 30 gal/acre

B = 4 feet

G = 12 gal/min (from chart*)

*The deluxe control will display the actual flow rate for your specific unit. For a more accurate max speed, use the flow rate from your control in this equation.

Here is the equation with these numbers:

$$S_{Max} \left(\frac{\text{Miles}}{\text{Hour}} \right) = 12 \left(\frac{\text{Gallons}}{\text{Minute}} \right) \times \left(\frac{1}{30 \left(\frac{\text{Gallons}}{\text{Acre}} \right)} \right) \times \left(\frac{1}{5 \text{ (Feet)}} \right) \times \left\{ \frac{60 \text{ Minutes}}{1 \text{ Hour}} \times \frac{1 \text{ Mile}}{5280 \text{ Feet}} \times \frac{43560 \text{ Square Feet}}{1 \text{ Acre}} \right\}$$

$$S_{Max} \left(\frac{\text{Miles}}{\text{Hour}} \right) = \frac{12}{30 \times 5} \times 495 \approx 40 \text{ Miles per hour}$$

MAINTENANCE

⚠ WARNING

Inspect the unit periodically for defects. Parts that are broken, missing, or worn out must be replaced immediately. Do not alter any part of the unit without prior written permission from the manufacturer.

⚠ WARNING

Always shut off vehicle before attempting to attach, detach, or service spray system.

⚠ WARNING

Do not operate a machine in need of maintenance.

NOTE: To prevent leaks, use a thread-sealing compound on all threaded connections. Do not use Teflon® tape, as fragments will clog the spray nozzles. Clamped connections may require periodic retightening

PERIODIC MAINTENANCE

- When servicing, you may need to close the shut-off valve and/or the return valve, to prevent stored brine from exiting the holding tank.
- Wash unit after each use to prevent material build-up and corrosion.
- Use dielectric grease on all electrical connections to prevent corrosion each time power or signal plugs are disconnected.
- Paint or oil all bare metal surfaces as needed.
- Inspect unit for defects: broken, worn, or bent parts and similar.
- Inspect all tubing, hoses, and harnesses for cracks and leaks.
- Clean the brine filter as needed. Close the shut-off valve and access the filter by unscrewing the top cap, then unscrewing the filter cover.
- Retighten bolts, screws, and other connections after first use and as needed.

CLEANING

- Clean the unit as desired. When power washing, keep away from electronics.
- Use caution if you are flushing the pumping system with water as it will accumulate in the valves and can cause damage if the water inside freezes. Use antifreeze if unit is to be stored in freezing temperatures.

END OF SEASON AND STORAGE

- Before long periods of storage flush out the tank, pumping system, and boom to remove salt build-up and prevent corrosion.
- Do not leave unused material in the unit for a prolonged period of time.

NOZZLE MAINTENANCE

Remove nozzles by pushing in and rotating the nozzle cap counterclockwise and clean as necessary.

When reassembling nozzles, make sure that the nozzle holes are in line with the boom. Failure to align the nozzle holes will result in inconsistent brine application.

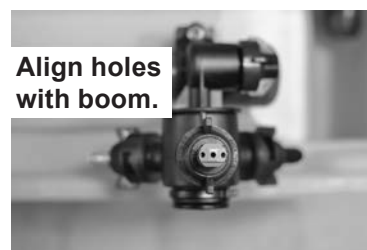

Teflon® is a registered trademark of E. I. du Pont de Nemours and Company.

TROUBLESHOOTING

⚠ WARNING

Always shut off vehicle before attempting to attach, detach, or service spray system.

⚠ WARNING

Do not operate a machine in need of maintenance.

NOTE: To prevent leaks, use a thread-sealing compound on all threaded connections. Do not use Teflon® tape, as fragments will clog the spray nozzles. Clamped connections may require periodic retightening.

| Problem | Possible Cause | Suggested Solution |
|--|---|---|
| Brine pumps in slowly or not at all | 1. Valve(s) are in closed position. | 1. Rotate handle to open the valve. |
| | 2. Brine filter is clogged. | 2. Remove and clean the brine filter. |
| No power to cab control (Ignition and control switches ON; no illumination of control indicator lights) | 1. Control connector plug is loose. | 1. Check plug connection at cab control. |
| | 2. Switched accessory connection is poor. | 2. Check accessory connection. |
| | 3. Faulty battery. | 3. Check for low battery. |
| | 4. Vehicle control harness is damaged. | 4. Replace or repair damaged wires or harness as required. |
| Brine spray is inconsistent or no spraying occurs | 1. Nozzles have become clogged. | 1. Remove and clean the affected nozzles. |
| | 2. Control connection is loose. | 2. Check harness connections. |
| | 3. Brine tank empty. | 3. Check brine tank level. |
| Unit is leaking | 1. Hose connections are loose. | 1. Retighten all hose connections; add thread sealing compound. |

Teflon® is a registered trademark of E. I. du Pont de Nemours and Company.

TROUBLESHOOTING – DELUXE CONTROL

A

Average Speed (for selected Data Set) is being displayed for 2 seconds.

bad ^{CAL}

Indicates memory fault. Cycling power will not clear the bad CAL message, it can only be cleared by entering Calibration or "Special Calibration" modes, checking and/or changing settings and exiting to save settings.

BLAST

BLAST is active (Blast key was pressed).

CLEAR

The message alerts the user that the currently selected counter will be cleared if the reset button is held for 2 seconds. Also serves as a reminder to use "+" button to select counters.

ESTOP

Emergency Stop caused by missing Flow Signal. Appears after "No Flow" error. Check flowmeter. Verify there is liquid flow and the tank is not empty.

Error

Trying to select Metric Units in Turf Mode or Turf Mode in Metric Units.

FILL

Rotary switch in any position, **FILL** will flash if tank level is equal to or less than Tank Set Point or Float Switch detects empty Tank. Fill TANK. If using TANK counter and Tank Alarm Set Point reset TANK counter by setting the rotary switch at the TANK position and pressing the "+" button for one second. Check to make sure TANK ALARM SET POINT is properly calibrated.

H

Highest Speed (for selected Data Set) is being displayed for 2 seconds.

L.P.r

In Lane Mode when a Boom is selected for Width Cal a letter will display for 1 second that identifies the selected Boom. After 1 second the displayed BOOM letters clear and the Boom Width is displayed.

LoP

Low Power. Check all power and ground connections.

no

boom

Will flash in display if rotary switch is in Width position, system is in Cal mode and no booms are turned on. Make sure system is in run and a boom switch is turned on, also check Run/Hold switch or sensor and connections.

no

FLo

Will flash in display if rotary switch is in RATE position and should have flow (In Run, some booms on, speed greater than 0) but no flow is detected. Check flowmeter and flow harness connections per Troubleshooting section.

no

SPEED

Will flash in display if rotary switch is in RATE position and there is no Speed signal regardless of all other conditions. Check speed sensor and connections per Troubleshooting section.

99999

Counters (DISTANCE or AREA or VOLUME) have reached their maximum. RESET (see page 25) to clear counters and resume counting.

SPEC

"Special" Calibration mode is active. Appears when entering Special Calibration mode (hold AUTO/MAN and CAL buttons while turning console on).

An unused SPECIAL CALIBRATE or LIVE CALIBRATE position.



Warn LED flashes when the Rate error is over 10% or Volume/Minute is below the Minimum, or Tank is less than Tank Set Point. It is on steady when in CAL mode or SPECIAL CAL mode or Test Speed if console is unlocked.



Audible Alarm

Alarm will sound if Alarm Enable is ON and either the Tank Level is below minimum or the Optional Tank Level Switch is active, or if Application Rate error rate is greater than 10% and the console is in Auto with adequate ground speed.



TrynEx International, LLC
531 Ajax Drive
Madison Heights, MI 48071-2429
www.snowexproducts.com

 A DIVISION OF DOUGLAS DYNAMICS, LLC

Copyright © 2017 Douglas Dynamics, LLC. All rights reserved. This material may not be reproduced or copied, in whole or in part, in any printed, mechanical, electronic, film or other distribution and storage media, without the written consent of TrynEx International, LLC. Authorization to photocopy items for internal or personal use by TrynEx International, LLC, outlets or equipment owner is granted.

TrynEx International, LLC, reserves the right under its product improvement policy to change construction or design details and furnish equipment when so altered without reference to illustrations or specifications used. TrynEx International, LLC, or the vehicle manufacturer may require or recommend optional equipment for sprayers. Do not exceed vehicle ratings with a sprayer. TrynEx International, LLC, offers a limited warranty for all equipment and accessories. See separately printed page for this important information. The following are registered (®) or unregistered (™) trademarks of Douglas Dynamics, LLC: SnowEx®, Liqui Maxx™.

Printed in U.S.A.