

# 33925

## MOUNT KIT COMPACT PLOW

RAM 1500

2019 - \_\_\_

### Installation Instructions

**▲ CAUTION**

Read this document before installing the snowplow.

**▲ CAUTION**

See your sales outlet/website for specific vehicle application recommendations before installation. The online selection system has specific vehicle and snowplow requirements.

**SAFETY DEFINITIONS**

**⚠ WARNING**  
 Indicates a potentially hazardous situation that, if not avoided, could result in death or serious personal injury.

**⚠ CAUTION**  
 Indicates a potentially hazardous situation that, if not avoided, may result in minor or moderate injury. It may also be used to alert against unsafe practices.

**NOTE:** Indicates a situation or action that can lead to damage to your snowplow and vehicle or other property. Other useful information can also be described.

**WARNING/CAUTION & INSTRUCTION LABELS**

Become familiar with and inform users about the warning/caution and instruction labels on the back of the blade.

**NOTE:** If labels are missing or cannot be read, see your sales outlet.

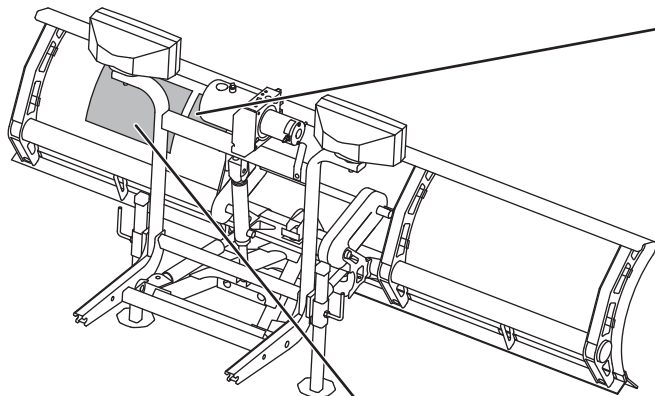

Instruction Label

Warning/Caution Label

<b>⚠ WARNING</b>	
	Lower blade when vehicle is parked.
	Do not exceed GVWR or GAWR including blade and ballast.
<b>⚠ CAUTION</b>	
	Read Owner's Manual before operating or servicing snowplow.
	Transport speed should not exceed 45 mph (72 km/h). Further reduce speed under adverse travel conditions.
	Plowing speed should not exceed 10 mph (16 km/h).
	See your sales outlet/website for specific vehicle application recommendations.

## SAFETY PRECAUTIONS

Improper installation and operation could cause personal injury and/or equipment and property damage. Read and understand labels and the Owner's Manual before installing, operating, or making adjustments.

### **⚠ WARNING**

**Lower the blade when vehicle is parked. Temperature changes could change hydraulic pressure, causing the blade to drop unexpectedly or damaging hydraulic components. Failure to do this could result in serious personal injury.**

### **⚠ WARNING**

**The driver shall keep bystanders clear of the blade when it is being raised, lowered, or angled. Do not stand between the vehicle and the blade or within 8 feet of a moving blade. A moving or falling blade could cause personal injury.**

### **⚠ WARNING**

**Keep hands and feet clear of the blade and A-frame when mounting or removing the snowplow. Moving or falling assemblies could cause personal injury.**

### **⚠ WARNING**

**Do not exceed GVWR or GAWR including the blade and ballast. The rating label is found on the driver-side vehicle door cornerpost.**

### **⚠ WARNING**

**To prevent accidental movement of the blade, always turn the control OFF whenever the snowplow is not in use. The power indicator light will turn OFF.**

### **⚠ WARNING**

**Remove blade assembly before placing vehicle on hoist.**

### **⚠ CAUTION**

**Refer to the online selection system for minimum vehicle recommendations and ballast requirements.**

## PERSONAL SAFETY

- Remove the ignition key and put the vehicle in PARK or in gear to prevent others from starting the vehicle during installation or service.
- Wear only snug-fitting clothing while working on your vehicle or snowplow.
- Do not wear jewelry or a necktie, and secure long hair.
- Wear safety goggles to protect your eyes from battery acid, gasoline, dirt, and dust.
- Avoid touching hot surfaces such as the engine, radiator, hoses, and exhaust pipes.
- Always have a fire extinguisher rated BC handy, for flammable liquids and electrical fires.

## FIRE AND EXPLOSION

### **⚠ WARNING**

**Gasoline is highly flammable and gasoline vapor is explosive. Never smoke while working on vehicle. Keep all open flames away from gasoline tank and lines. Wipe up any spilled gasoline immediately.**

Be careful when using gasoline. Do not use gasoline to clean parts. Store only in approved containers away from sources of heat or flame.

## CELL PHONES

A driver's first responsibility is the safe operation of the vehicle. The most important thing you can do to prevent a crash is to avoid distractions and pay attention to the road. Wait until it is safe to operate Mobile Communication Equipment such as cell phones, text messaging devices, pagers, or two-way radios.

## VENTILATION

### **⚠ WARNING**

**Vehicle exhaust contains lethal fumes. Breathing these fumes, even in low concentrations, can cause death. Never operate a vehicle in an enclosed area without venting exhaust to the outside.**

**NOISE**

Airborne noise emission during use is below 70 dB(A) for the snowplow operator.

**VIBRATION**

Operating snowplow vibration does not exceed 2.5 m/s<sup>2</sup> to the hand-arm or 0.5 m/s<sup>2</sup> to the whole body.

**TORQUE CHART**

**⚠ CAUTION**

Read instructions before assembling. Fasteners should be finger tight until instructed to tighten according to the torque chart. Use standard methods and practices when attaching snowplow, including proper personal protective safety equipment.

Recommended Fastener Torque Chart					
Inch Fasteners Grade 5 and Grade 8					
Size	Torque (ft-lb)		Size	Torque (ft-lb)	
	Grade 5	Grade 8		Grade 5	Grade 8
1/4-20	8.4	11.9	9/16-12	109	154
1/4-28	9.7	13.7	9/16-18	121	171
5/16-18	17.4	24.6	5/8-11	150	212
5/16-24	19.2	27.3	5/8-18	170	240
3/8-16	30.8	43.6	3/4-10	269	376
3/8-24	35.0	49.4	3/4-16	297	420
7/16-14	49.4	69.8	7/8-9	429	606
7/16-20	55.2	77.9	7/8-14	474	669
1/2-13	75.3	106.4	1-8	644	909
1/2-20	85.0	120.0	1-12	704	995

Metric Fasteners Class 8.8 and 10.9					
Size	Torque (ft-lb)		Size	Torque (ft-lb)	
	Class 8.8	Class 10.9		Class 8.8	Class 10.9
M6 x 1.00	7.7	11.1	M20 x 2.50	325	450
M8 x 1.25	19.5	26.9	M22 x 2.50	428	613
M10 x 1.50	38.5	53.3	M24 x 3.00	562	778
M12 x 1.75	67	93	M27 x 3.00	796	1139
M14 x 2.00	107	148	M30 x 3.50	1117	1545
M16 x 2.00	167	231	M33 x 3.50	1468	2101
M18 x 2.50	222	318	M36 x 4.00	1952	2701

These torque values apply to fasteners except those noted in the instructions.

**INSTALLATION INSTRUCTIONS**

**NOTE: For easier assembly and installation, vehicle and all snowplow components should be on a smooth, level, hard surface, such as concrete.**

1. Remove the active air dam from underneath the vehicle. Retain for reinstallation if mount is removed.

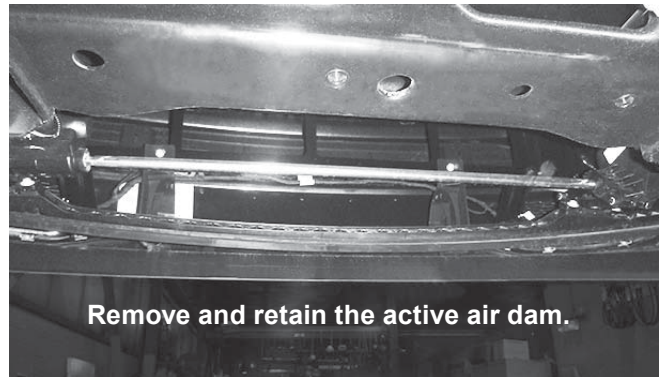

2. Remove the bumper from the vehicle and retain it for reinstallation. Remove the tow hooks. Retain the tow hooks for reinstallation if mount is removed in the future.





3. With the help of a second person, place the mount between the frame tubes. Push the mount up against the bottom of the frame tubes until the mount stops contact the frame. Push the mount to the rear until the mount side plates are equidistant from the frame welds as shown below. Tightly clamp the mount in place.

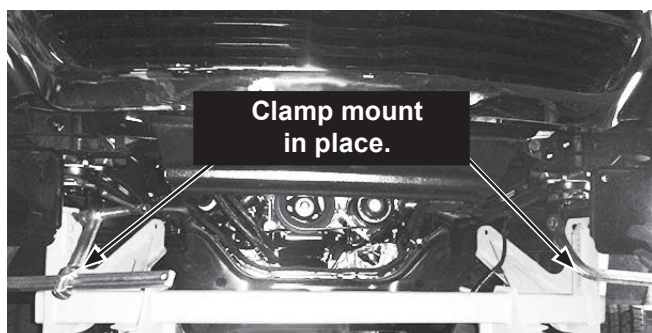
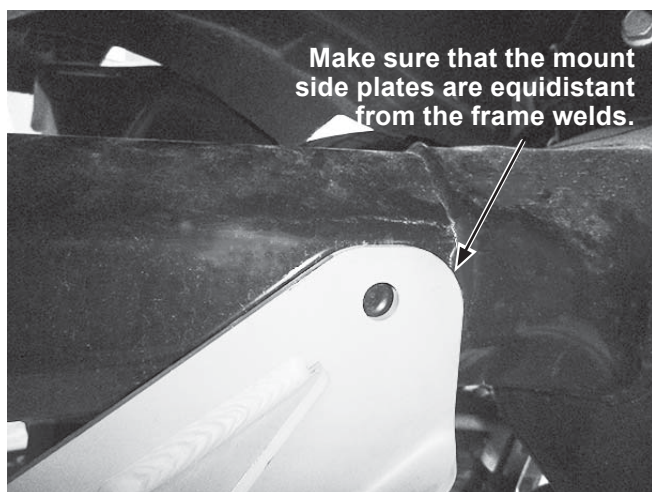
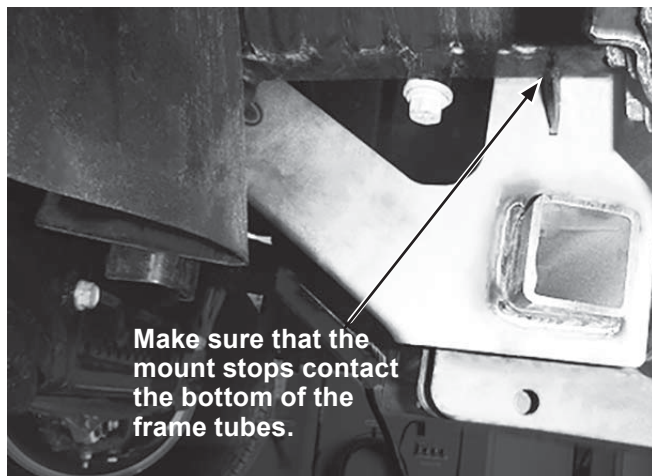

### **⚠ CAUTION**

**Before drilling any holes, check to be sure that no vehicle wiring or other components could be damaged.**

4. Using the front mount holes as guides, drill  $3/64$ " holes through the frame.

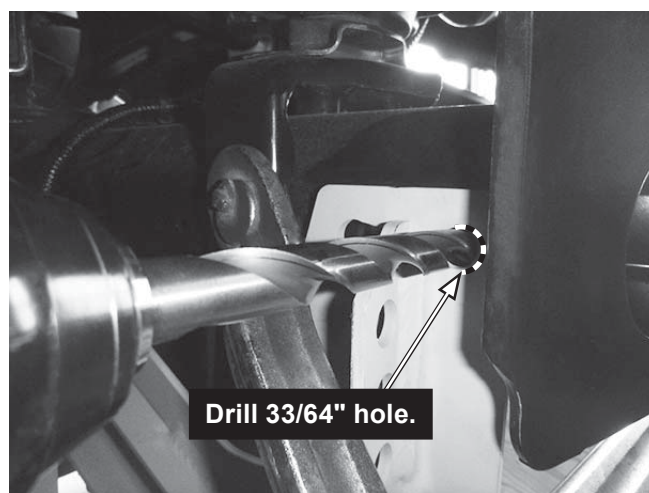

5. Place  $1/2$ " washers on two  $1/2$ " x  $1-1/4$ " cap screws. From inside the frame, insert the fasteners through the holes drilled in Step 4. Install  $1/2$ " locknuts on the cap screws and finger tighten. Remove the clamps holding the mount in place.



6. Ensure that the mount stops are still contacting the frame. Using the rear mount holes as guides, drill 33/64" holes through the frame.



7. Locate the 1/2" x 1-1/4" cap screws with 18" handles. Insert the cap screw handles into the frame and insert the cap screws through the holes drilled in Step 6. Install 1/2" locknuts on the cap screws and finger tighten.

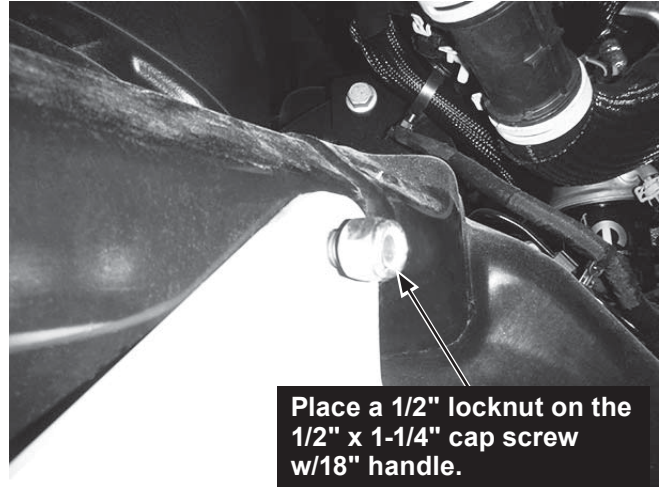

**⚠ CAUTION**

Before drilling any holes, check to be sure that no vehicle wiring or other components could be damaged.

8. Using the remaining slotted holes as guides, drill 33/64" holes through the frame.



9. Place 1/2" washers on the 1/2" x 1-1/2" cap screws with 7" handles. From inside the frame, insert the cap screws with handles through the holes drilled in Step 8. Install 1/2" washers and 1/2" locknuts on the cap screws and finger tighten.

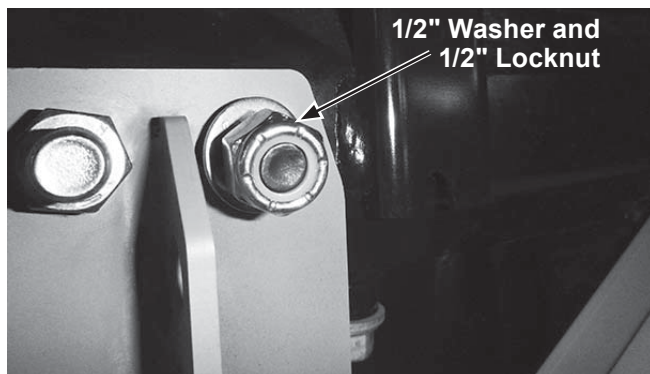
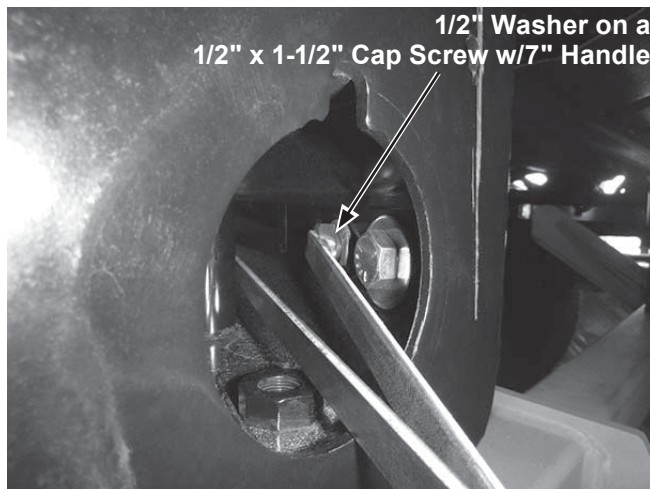

10. Tighten all fasteners according to the torque chart.

11. Trim the excess handle length of cap screw handles to avoid interference with the bumper.

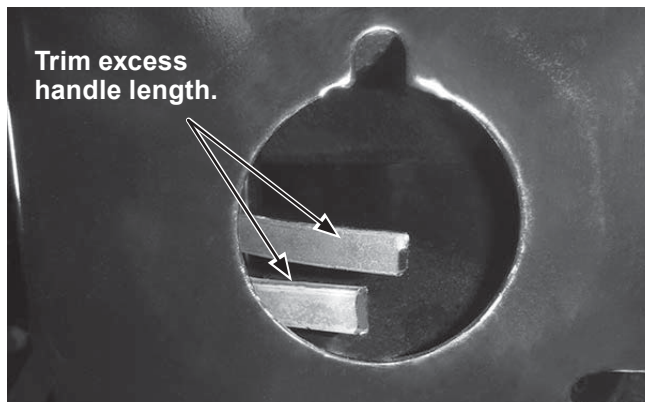

12. Reinstall the bumper and trim the air dam as necessary to allow clearance for the mount. It may be necessary to remove the air dam from the bumper for easier trimming.

---

**NOTE: After five to ten hours of snowplow usage, retorque all mount assembly fasteners.**

---

The company reserves the right under its product improvement policy to change construction or design details and furnish equipment when so altered without reference to illustrations or specifications used. This equipment manufacturer or the vehicle manufacturer may require or recommend optional equipment for snow removal. Do not exceed vehicle ratings with a snowplow. The company offers a limited warranty for all snowplows and accessories. See separately printed page for this important information.

**Printed in U.S.A.**

---