

# 33212-2

## MOUNT KIT

<b>Isuzu NPR</b>	<b>2008 -</b> ___
<b>Isuzu NRR/NQR (16,000 GVWR max.†)</b>	<b>2008 -</b> ___
<b>GM W-Series</b>	<b>2008 -</b> 10
<b>GM LCF 3500/3500 HD/4500/4500 HD</b>	<b>2016 -</b> ___
<b>GM LCF 4500 XD/5500 HD/5500 XD</b> <b>(16,000 GVWR max.†)</b>	<b>2016 -</b> ___

### Installation Instructions

**⚠ CAUTION**

Read this document before installing the snowplow.

**⚠ CAUTION**

See your sales outlet/website for specific vehicle application recommendations before installation. The online selection system has specific vehicle and snowplow requirements.

† When snowplow is attached.

**SAFETY DEFINITIONS**

**⚠ WARNING**  
 Indicates a potentially hazardous situation that, if not avoided, could result in death or serious personal injury.

**⚠ CAUTION**  
 Indicates a potentially hazardous situation that, if not avoided, may result in minor or moderate injury. It may also be used to alert against unsafe practices.

**NOTE:** Indicates a situation or action that can lead to damage to your snowplow and vehicle or other property. Other useful information can also be described.

**WARNING/CAUTION & INSTRUCTION LABELS**

Become familiar with and inform users about the warning and instruction labels on the back of the blade.

**NOTE:** If labels are missing or cannot be read, see your sales outlet.

**Warning and Caution Label**

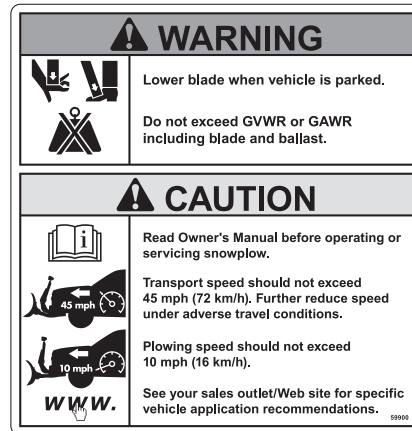

Attach/Detach Instruction Label

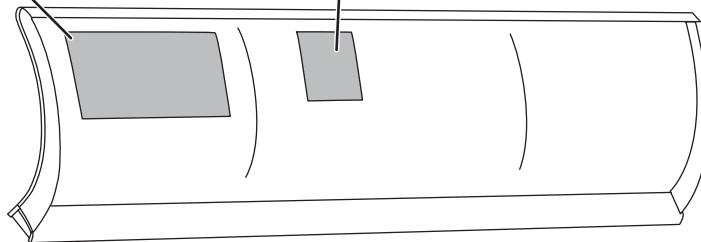

**For the following Vehicle Applications Only:**

**Isuzu NQR and NRR,**

**GM LCF 4500 XD, 5500 HD, and 5500 XD**

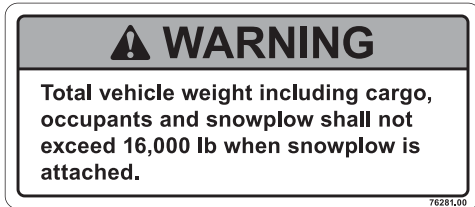

**Label shall be installed in visible location inside vehicle cab.**

## SAFETY PRECAUTIONS

Improper installation and operation could cause personal injury and/or equipment and property damage. Read and understand labels and the Owner's Manual before installing, operating, or making adjustments.

### **⚠ WARNING**

**Lower the blade when vehicle is parked. Temperature changes could change hydraulic pressure, causing the blade to drop unexpectedly or damaging hydraulic components. Failure to do this could result in serious personal injury.**

### **⚠ WARNING**

**The driver shall keep bystanders clear of the blade when it is being raised, lowered, or angled. Do not stand between the vehicle and the blade or within 8 feet of a moving blade. A moving or falling blade could cause personal injury.**

### **⚠ WARNING**

**Keep hands and feet clear of the blade and A-frame when mounting or removing the snowplow. Moving or falling assemblies could cause personal injury.**

### **⚠ WARNING**

**Do not exceed GVWR or GAWR including the blade and ballast. The rating label is found on the driver-side vehicle door cornerpost.**

### **⚠ WARNING**

**To prevent accidental movement of the blade, always turn the control OFF whenever the snowplow is not in use. The power indicator light will turn OFF.**

### **⚠ WARNING**

**Remove blade assembly before placing vehicle on hoist.**

### **⚠ CAUTION**

**Refer to the online selection system for minimum vehicle recommendations and ballast requirements.**

## PERSONAL SAFETY

- Remove ignition key and put the vehicle in park or in gear to prevent others from starting the vehicle during installation or service.
- Wear only snug-fitting clothing while working on your vehicle or snowplow.
- Do not wear jewelry or a necktie, and secure long hair.
- Wear safety goggles to protect your eyes from battery acid, gasoline, dirt, and dust.
- Avoid touching hot surfaces such as the engine, radiator, hoses, and exhaust pipes.
- Always have a fire extinguisher rated BC handy, for flammable liquids and electrical fires.

## FIRE AND EXPLOSION

### **⚠ WARNING**

**Gasoline is highly flammable and gasoline vapor is explosive. Never smoke while working on vehicle. Keep all open flames away from gasoline tank and lines. Wipe up any spilled gasoline immediately.**

Be careful when using gasoline. Do not use gasoline to clean parts. Store only in approved containers away from sources of heat or flame.

## CELL PHONES

A driver's first responsibility is the safe operation of the vehicle. The most important thing you can do to prevent a crash is to avoid distractions and pay attention to the road. Wait until it is safe to operate Mobile Communication Equipment such as cell phones, text messaging devices, pagers, or two-way radios.

## VENTILATION

### **⚠ WARNING**

**Vehicle exhaust contains lethal fumes. Breathing these fumes, even in low concentrations, can cause death. Never operate a vehicle in an enclosed area without venting exhaust to the outside.**

## NOISE

Airborne noise emission during use is below 70 dB(A) for the snowplow operator.

## VIBRATION

Operating snowplow vibration does not exceed 2.5 m/s<sup>2</sup> to the hand-arm or 0.5 m/s<sup>2</sup> to the whole body.





## TORQUE CHART

### ⚠ CAUTION





Read instructions before assembling. Fasteners should be finger tight until instructed to tighten according to the torque chart. Use standard methods and practices when attaching snowplow, including proper personal protective safety equipment.

### Recommended Fastener Torque Chart

#### Inch Fasteners Grade 5 and Grade 8

Size	Torque (ft-lb)		Size	Torque (ft-lb)	
	 Grade 5	 Grade 8		 Grade 5	 Grade 8
1/4-20	8.4	11.9	9/16-12	109	154
1/4-28	9.7	13.7	9/16-18	121	171
5/16-18	17.4	24.6	5/8-11	150	212
5/16-24	19.2	27.3	5/8-18	170	240
3/8-16	30.8	43.6	3/4-10	269	376
3/8-24	35.0	49.4	3/4-16	297	420
7/16-14	49.4	69.8	7/8-9	429	606
7/16-20	55.2	77.9	7/8-14	474	669
1/2-13	75.3	106.4	1-8	644	909
1/2-20	85.0	120.0	1-12	704	995

#### Metric Fasteners Class 8.8 and 10.9

Size	Torque (ft-lb)		Size	Torque (ft-lb)	
	 Class 8.8	 Class 10.9		 Class 8.8	 Class 10.9
M6 x 1.00	7.7	11.1	M20 x 2.50	325	450
M8 x 1.25	19.5	26.9	M22 x 2.50	428	613
M10 x 1.50	38.5	53.3	M24 x 3.00	562	778
M12 x 1.75	67	93	M27 x 3.00	796	1139
M14 x 2.00	107	148	M30 x 3.50	1117	1545
M16 x 2.00	167	231	M33 x 3.50	1468	2101
M18 x 2.50	222	318	M36 x 4.00	1952	2701

These torque values apply to fasteners except those noted in the instructions.

## INSTALLATION INSTRUCTIONS

**NOTE:** For easier assembly and installation, vehicle and all snowplow components should be on a smooth, level, hard surface, such as concrete.

1. Apply the maximum weight warning label in a visible location inside the vehicle cab. Inform the end user of its placement. **(Isuzu NRR and NQR vehicle applications only.)**

2. Remove the plastic bumper cover.

### ⚠ CAUTION

Use caution not to pinch, cut, or drill through any wires or hoses running along the frame rails.

3. From inside the frame rails, drill one 1/2" hole through each frame rail and tie down bracket. Use the hole in the inner frame rail as a guide. Place a 1/2" washer on a 1/2" x 1-3/4" cap screw and insert it through the drilled hole in each frame rail and secure with a 1/2" washer and 1/2" locknut. Tighten according to the torque chart.

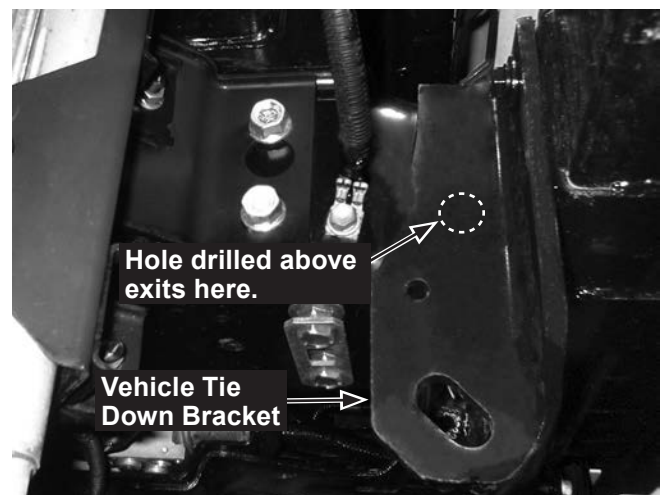
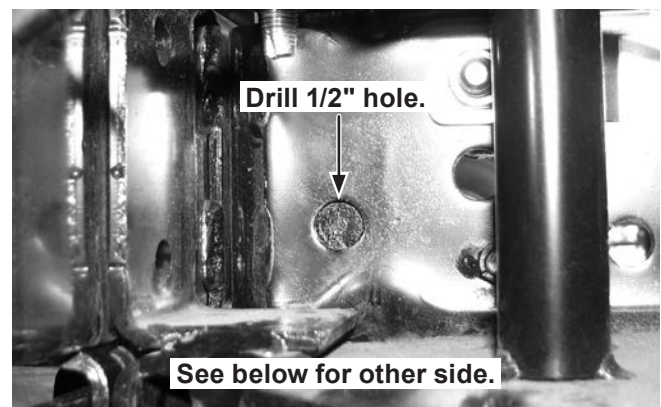

4. If the truck is equipped with air-conditioning, remove and retain the two rear fasteners attaching the AC condenser to the frame (shown). Loosen the two front fasteners (not shown) enough so that the condenser is free to rotate away from the frame approximately 1/4".

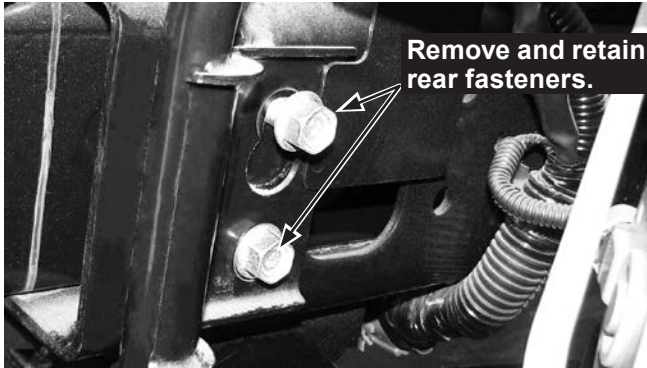

5. On the passenger's side, loosen the transmission/emergency brake cable bracket so that the bracket's retaining tab can be removed from the 3/4" hole where it is captured.

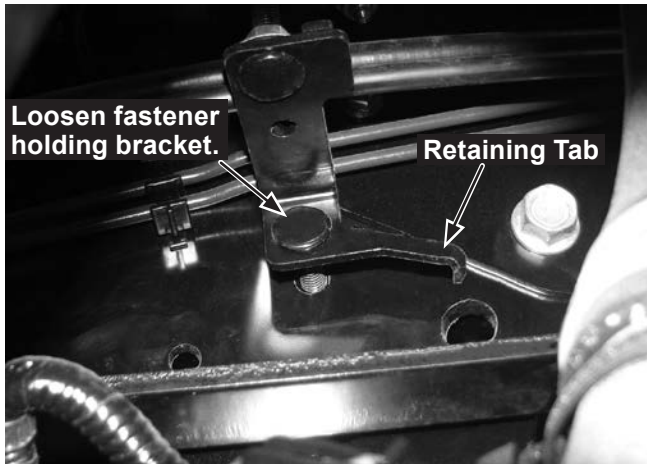

6. Install the passenger-side thrust arm by positioning the hole in the thrust arm around the spring shackle fastener (shown, above right). Insert a 5/8" x 1-3/4" cap screw with 5/8" washer through the 3/4" hole in the frame and through the 11/16" hole in the rear of the thrust arm. The head of the cap screw should be placed on the inside of the frame rail. Loosely attach using a 5/8" locknut.

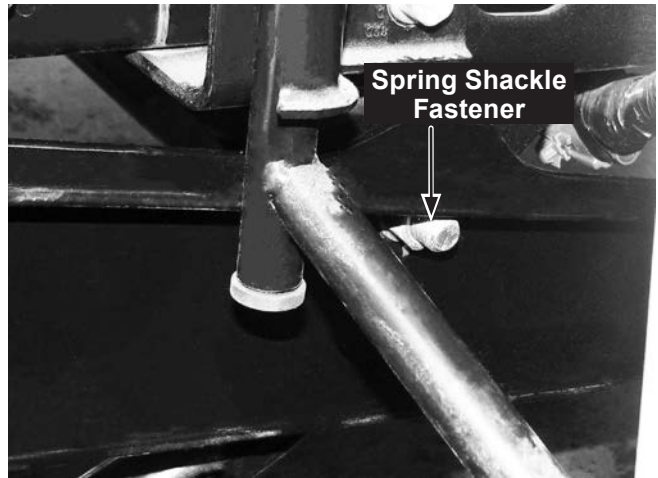

7. Tighten the transmission/emergency brake cable bracket, reforming the retaining tab as necessary to clear the newly installed 5/8" cap screw.
8. If the truck is equipped with air-conditioning, place one 1/2" washer between the frame rail and the rear AC condenser bracket for both of the previously removed rear AC bracket fasteners. Reinstall the fasteners through the AC bracket, washers, and frame rail. Tighten all AC bracket fasteners according to the torque chart.
9. Install the driver-side thrust arm by positioning the hole in the thrust arm around the spring shackle fastener. Insert a 5/8" x 1-3/4" cap screw with 5/8" washer through the 3/4" hole in the frame and through the 11/16" hole in the rear of the thrust arm. The head of the cap screw must be placed on the inside of the frame rail to provide clearance for the vehicle electrical harness running along the frame rail in this area. Loosely attach using a 5/8" locknut.



10. Remove the two lower bumper fasteners shown. Remove the plastic harness retention clip from the driver-side tie down bracket if equipped. Position the front mount between the vehicle tie down brackets, ensuring that the previously installed thrust arms are on the inside surface of the front mount side plates. Insert a 5/8" x 1-3/4" cap screw through the side plates of the front mount and through the slot in the tie down bracket. Loosely reinstall the lower bumper fasteners.

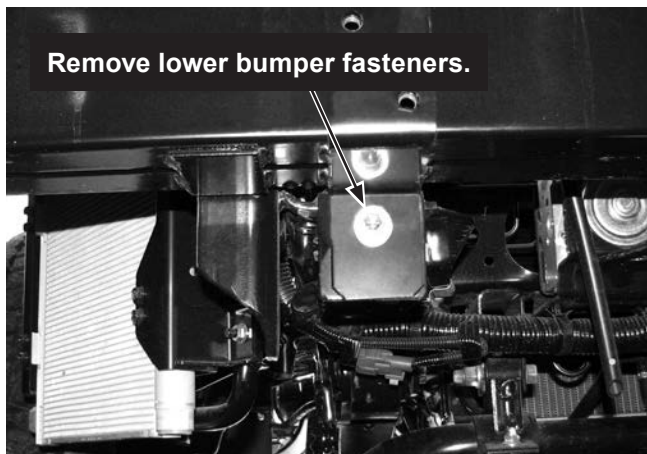

11. Attach the driver-side and passenger-side thrust arms to the front mount using three 1/2" x 1-3/4" cap screws and 1/2" locknuts per thrust arm, leaving the fasteners loose at this time.

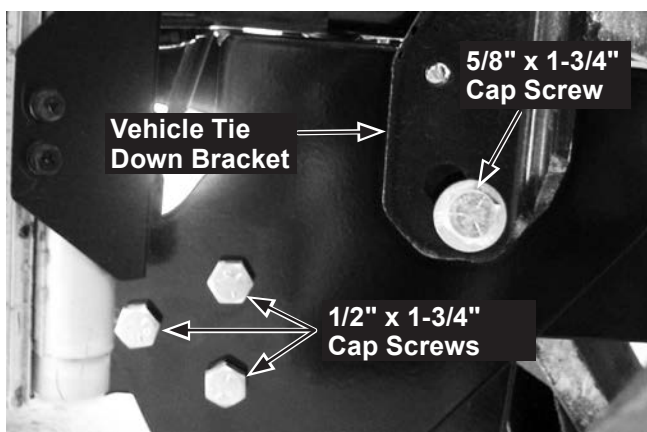

12. Tighten the two lower bumper bolts and the 5/8" fasteners attaching the front mount side plates to the vehicle tie down brackets according to the torque chart.

13. Ream the small hole in each tie down bracket to 1/2" diameter. Insert a 1/2" x 1-3/4" cap screw through the mount and reamed tie down bracket holes on each side of the vehicle and tighten according to the torque chart.

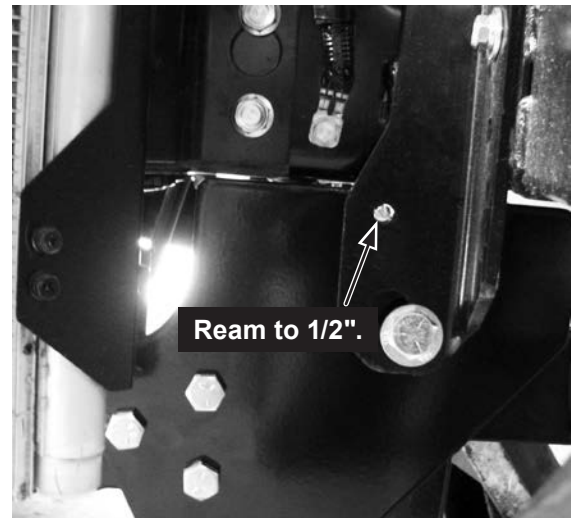

**⚠ CAUTION**

Use caution not to pinch, cut, or drill through any wires or hoses running along the frame rails.

14. Using the two 9/16" holes in each thrust arm as guides, drill 17/32" holes through the frame rails. Insert 1/2" x 1-3/4" cap screws with 1/2" washers through the drilled holes, ensuring that the cap screw heads are on the inside surface of the frame. Secure with 1/2" locknuts and tighten according to the torque chart.

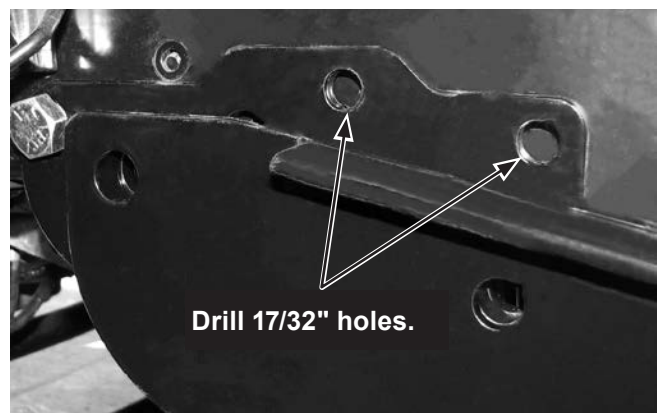

15. Reinstall the plastic bumper cover.

**NOTE: After five to ten hours of snowplow usage, retorque all mount assembly fasteners.**

The company reserves the right under its product improvement policy to change construction or design details and furnish equipment when so altered without reference to illustrations or specifications used. This equipment manufacturer or the vehicle manufacturer may require or recommend optional equipment for snow removal. Do not exceed vehicle ratings with a snowplow. The company offers a limited warranty for all snowplows and accessories. See separately printed page for this important information.

**Printed in U.S.A.**

---