

31273

MOUNT KIT PERSONAL PLOW

Ford F-150

2015-__

Installation Instructions

⚠ CAUTION

Read this document before installing the snowplow.

⚠ CAUTION

See your sales outlet/website for specific vehicle application recommendations before installation. The online selection system has specific vehicle and snowplow requirements.

SAFETY DEFINITIONS

⚠ WARNING
 Indicates a potentially hazardous situation that, if not avoided, could result in death or serious personal injury.

⚠ CAUTION
 Indicates a potentially hazardous situation that, if not avoided, may result in minor or moderate injury. It may also be used to alert against unsafe practices.







NOTE: Indicates a situation or action that can lead to damage to your snowplow and vehicle or other property. Other useful information can also be described.

WARNING/CAUTION & INSTRUCTION LABELS

Become familiar with and inform users about the warning/caution labels on the back of the blade and the instruction label on the headgear.

NOTE: If labels are missing or cannot be read, see your sales outlet.

Warning and Caution Label

⚠ WARNING	
	Lower blade when vehicle is parked.
	Do not exceed GVWR or GAWR including blade and ballast.
⚠ CAUTION	
	Read Owner's Manual before operating or servicing snowplow.
	Transport speed should not exceed 45 mph (72 km/h). Further reduce speed under adverse travel conditions.
	Plowing speed should not exceed 10 mph (16 km/h).
	See your sales outlet/website for specific vehicle application recommendations.

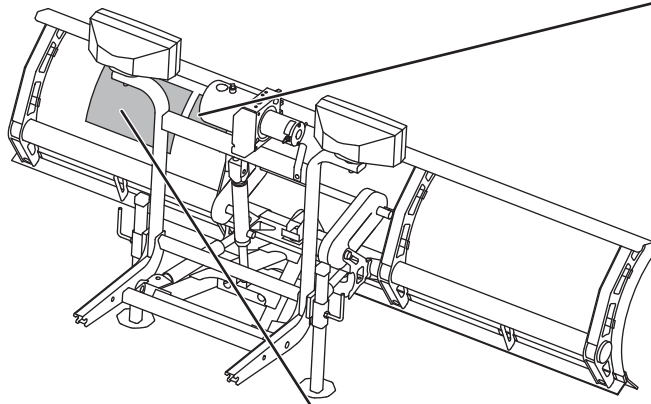

This snowplow is for personal/homeowner use only.

- ATTACH INSTRUCTIONS**
1. Make certain both **connecting pins** are fully retracted.
 2. Drive vehicle slowly to completely insert **attachment arms** into **receiver assembly** slots.
 3. Twist both **connecting pins** to release spring tension, then push **plow gear** toward vehicle so **connecting pins** fully engage holes in **attachment arms**.
 4. Loosen one **jack handle** and slide **jack sleeve** down below **jack retainer**. Remove **jack** and retighten **jack handle**. Repeat for other **jack** and store them.
 5. Connect all electrical cables from vehicle to snowplow.

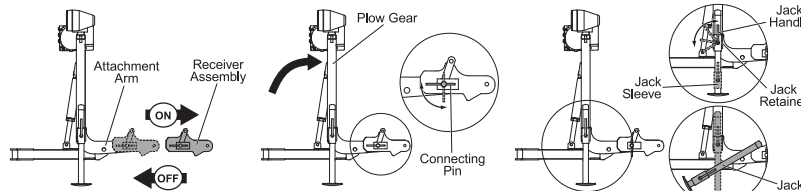

U.S. patents 6,941,685; 7,400,058; 7,737,576; and other patents pending.

- DETACH INSTRUCTIONS**
1. Put blade on ground using **LOWER/FLOAT** on snowplow control. Leave control **ON** and in **FLOAT**.
 2. Attach **jacks**. Loosen **jack handle**, put **jack** on ground, and raise **jack sleeve** until fully engaging **jack retainer**. Tighten **jack handle**. Repeat for other **jack**.
 3. While pushing **plow gear** toward vehicle to release **connecting pin** tension, pull **connecting pin** out on one side and twist pin to keep pin retracted. Repeat procedure for other **connecting pin**.
 4. Disconnect all electrical cables.
 5. Back vehicle away from snowplow.
 6. See Owner's Manual for proper snowplow storage.
- Read Owner's Manual for complete instructions.**

Attach/Detach Instruction Label

SAFETY PRECAUTIONS

Improper installation and operation could cause personal injury and/or equipment and property damage. Read and understand labels and the Owner's Manual before installing, operating, or making adjustments.

⚠ WARNING

Lower the blade when the vehicle is parked. Temperature changes could change hydraulic pressure, causing the blade to drop unexpectedly or damaging hydraulic components. Failure to do this could result in serious personal injury.

⚠ WARNING

The driver shall keep bystanders clear of the blade when it is being raised, lowered, or angled. Do not stand between vehicle and blade or within 8 feet of a moving blade. A moving or falling blade could cause personal injury.

⚠ WARNING

Keep hands and feet clear of the blade and A-frame when mounting or removing the snowplow. Moving or falling assemblies could cause personal injury.

⚠ WARNING

Do not exceed GVWR or GAWR including the blade and ballast. The rating label is found on the driver-side vehicle door cornerpost.

⚠ WARNING

To prevent accidental movement of the blade, always turn the control OFF whenever the snowplow is not in use. The power indicator light will turn OFF.

⚠ WARNING

Remove blade assembly before placing vehicle on hoist.

⚠ CAUTION

Refer to the online selection system for minimum vehicle recommendations and ballast requirements.

PERSONAL SAFETY

- Remove the ignition key and put the vehicle in PARK or in gear to prevent others from starting the vehicle during installation or service.
- Wear only snug-fitting clothing while working on your vehicle or snowplow.
- Do not wear jewelry or a necktie, and secure long hair.
- Wear safety goggles to protect your eyes from battery acid, gasoline, dirt, and dust.
- Avoid touching hot surfaces such as the engine, radiator, hoses, and exhaust pipes.
- Always have a fire extinguisher rated BC handy, for flammable liquids and electrical fires.

FIRE AND EXPLOSION

⚠ WARNING

Gasoline is highly flammable and gasoline vapor is explosive. Never smoke while working on vehicle. Keep all open flames away from gasoline tank and lines. Wipe up any spilled gasoline immediately.

Be careful when using gasoline. Do not use gasoline to clean parts. Store only in approved containers away from sources of heat or flame.

CELL PHONES

A driver's first responsibility is the safe operation of the vehicle. The most important thing you can do to prevent a crash is to avoid distractions and pay attention to the road. Wait until it is safe to operate Mobile Communication Equipment such as cell phones, text messaging devices, pagers, or two-way radios.

VENTILATION

⚠ WARNING

Vehicle exhaust contains lethal fumes. Breathing these fumes, even in low concentrations, can cause death. Never operate a vehicle in an enclosed area without venting exhaust to the outside.

NOISE

Airborne noise emission during use is below 70 dB(A) for the snowplow operator.









VIBRATION

Operating snowplow vibration does not exceed 2.5 m/s² to the hand-arm or 0.5 m/s² to the whole body.

TORQUE CHART

⚠ CAUTION

Read instructions before assembling. Fasteners should be finger tight until instructed to tighten according to the torque chart. Use standard methods and practices when attaching snowplow, including proper personal protective safety equipment.

Recommended Fastener Torque Chart					
Inch Fasteners Grade 5 and Grade 8					
Size	Torque (ft-lb)		Size	Torque (ft-lb)	
	 Grade 5	 Grade 8		 Grade 5	 Grade 8
1/4-20	8.4	11.9	9/16-12	109	154
1/4-28	9.7	13.7	9/16-18	121	171
5/16-18	17.4	24.6	5/8-11	150	212
5/16-24	19.2	27.3	5/8-18	170	240
3/8-16	30.8	43.6	3/4-10	269	376
3/8-24	35.0	49.4	3/4-16	297	420
7/16-14	49.4	69.8	7/8-9	429	606
7/16-20	55.2	77.9	7/8-14	474	669
1/2-13	75.3	106.4	1-8	644	909
1/2-20	85.0	120.0	1-12	704	995
Metric Fasteners Class 8.8 and 10.9					
Size	Torque (ft-lb)		Size	Torque (ft-lb)	
	 Class 8.8	 Class 10.9		 Class 8.8	 Class 10.9
M6 x 1.00	7.7	11.1	M20 x 2.50	325	450
M8 x 1.25	19.5	26.9	M22 x 2.50	428	613
M10 x 1.50	38.5	53.3	M24 x 3.00	562	778
M12 x 1.75	67	93	M27 x 3.00	796	1139
M14 x 2.00	107	148	M30 x 3.50	1117	1545
M16 x 2.00	167	231	M33 x 3.50	1468	2101
M18 x 2.50	222	318	M36 x 4.00	1952	2701

These torque values apply to fasteners except those noted in the instructions.

INSTALLATION INSTRUCTIONS

NOTE: For easier assembly and installation, the vehicle and all snowplow components should be on a smooth, level, hard surface, such as concrete.

MOUNT INSTALLATION

1. Remove the lower air dam.

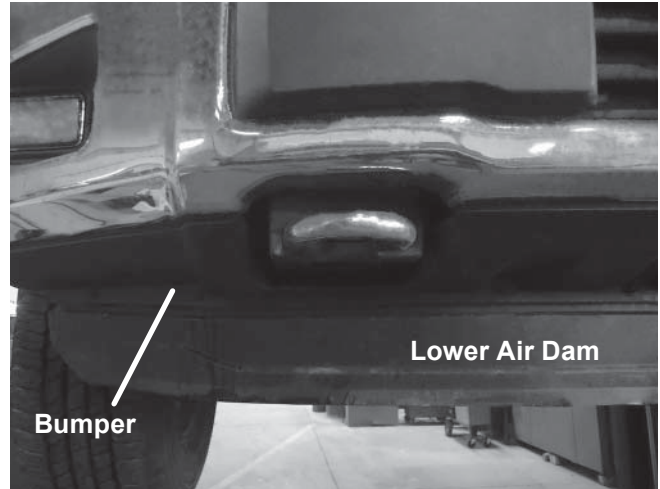

2. Remove the front tow hook fasteners and loosen the rear fasteners. Remove the tow hooks by sliding them forward and then downward. Leave the rear fastener in position as shown below.

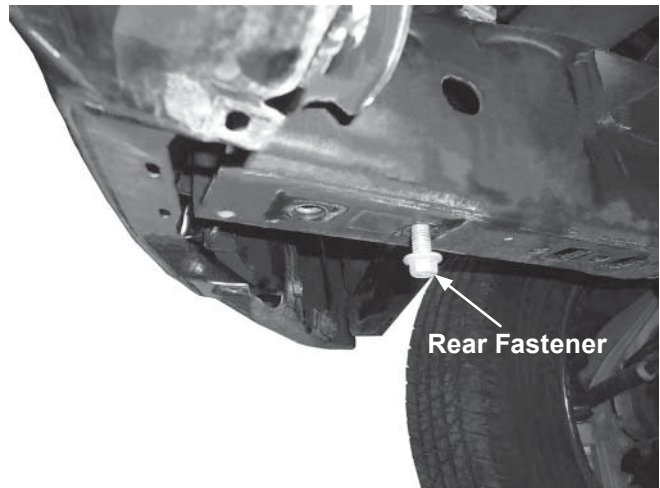

- Place the passenger-side mount up against the frame. Slide the mount forward around the rear tow hook fastener as shown. Insert the front tow hook fastener up through the mount hole and thread into the nut bar (a clip with two nuts attached, original to the vehicle) until the mount lightly touches the bottom surface of the vehicle frame. Do not tighten the fasteners at this time, as the mount must be free to move laterally for the following steps.

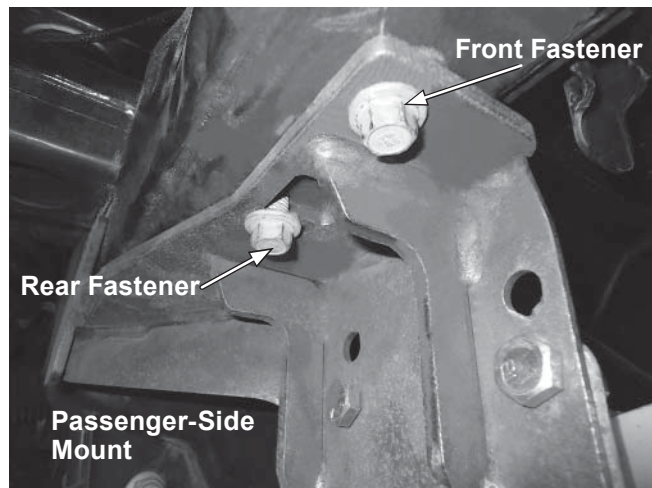

- Repeat Step 3 for the driver's side.

⚠ CAUTION

Use caution not to pinch, cut, or drill through any wires or hoses running along the frame rail.

- Ream the front hole in the passenger's side of the frame (underneath the front mount hole) to a diameter of $17/32$ ".



⚠ CAUTION

Use caution not to pinch, cut or drill through any wires or hoses running along the frame rail.

- Ream the rear hole in the driver's side of the frame to a diameter of $17/32$ ". The reamed hole should be located in the rear of the mount slot as shown.

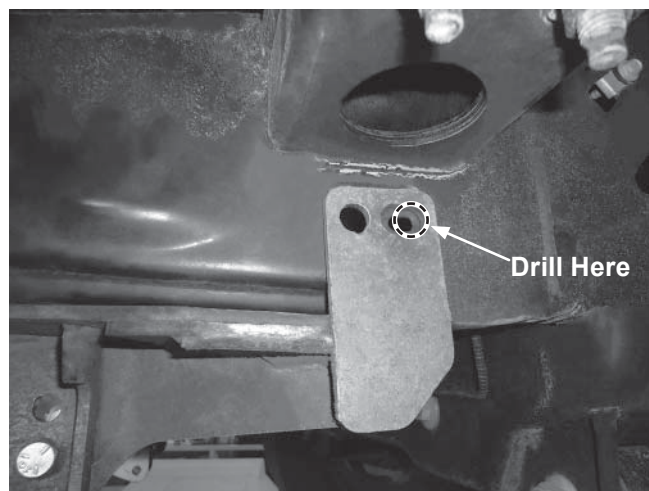

- Attach a $1/2$ " washer to each of two $1/2$ " x $1-1/2$ " cap screws with handles and insert them into the frame rail through the opening shown and then through the mount holes. Start with the front mount hole to ensure that the rear fastener handle will not block access.

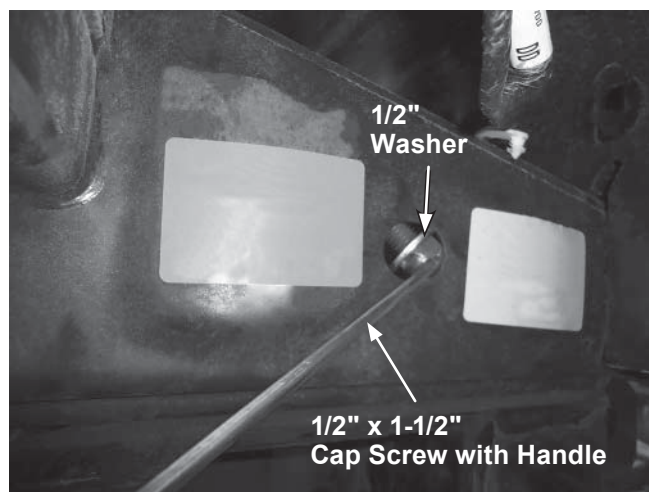

- Secure the other side of the frame rail with a 1/2" washer and 1/2" locknut as shown. Hand tighten the fasteners so that the mount tab comes just into contact with the frame rail. Do not fully tighten at this time. Repeat Steps 7 and 8 on the driver's side of the frame rail.

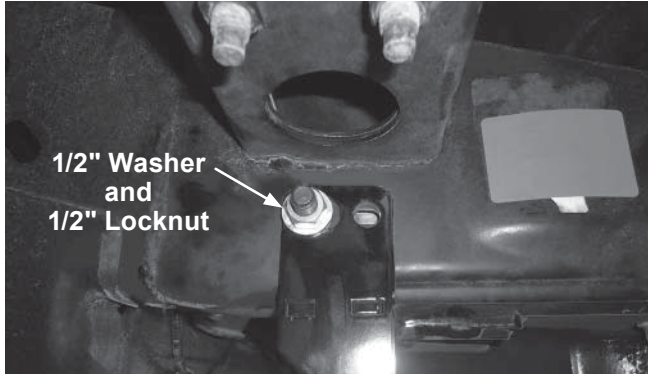

⚠ CAUTION
 Use caution not to pinch, cut or drill through any wires or hoses running along the frame rail.

- Using the front mount tab hole as a guide, drill a 17/32" diameter hole in the driver's side of the frame. Attach a 1/2" washer to a 1/2" x 1-1/2" cap screw with handle and use the opening shown to insert it into the frame rail and back out through the drilled hole. Secure with a 1/2" locknut. A washer is not required between the locknut and the mount tab. Tighten the locknut until the mount tab is flush with the frame. Do not fully tighten at this time. Repeat on the passenger's side of the frame.

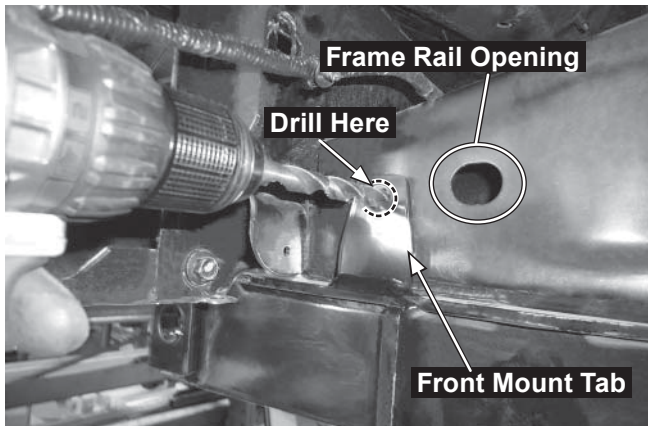

- Tighten all fasteners according to the torque chart provided. Start with the tow hook fasteners, then tighten the front tab fasteners, followed by the rear tab fasteners.
- Install the pushbeam using eight 1/2" x 1-1/2" cap screws (four on each end). Use the set of holes that positions the pushbeam closest to 10-1/4" from the ground when measured as shown below.

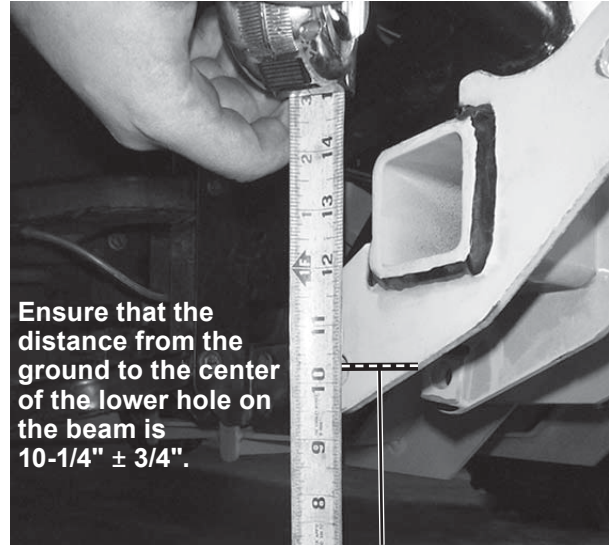

Secure the pushbeam with 1/2" locknuts. Tighten the fasteners according to the torque chart.

- Measure the distance between the pushbeam rear hole and the ground. If it exceeds 11-1/2", install the accessory Height Adapter Plate Kit (PN 77555) to ensure optimum plowing performance.
- Attach the snowplow. The lower section of the plastic bumper may require additional trimming in order to clear all components.

NOTE: After five to ten hours of snowplow usage, retorque all mount assembly fasteners.

The company reserves the right under its product improvement policy to change construction or design details and furnish equipment when so altered without reference to illustrations or specifications used. This equipment manufacturer or the vehicle manufacturer may require or recommend optional equipment for snow removal. Do not exceed vehicle ratings with a snowplow. The company offers a limited warranty for all snowplows and accessories. See separately printed page for this important information.