

30999

MOUNT KIT

Dodge Ram 1500 4X4

2006 - 08

Installation Instructions

⚠ CAUTION

Read this document before installing the snowplow.

⚠ CAUTION

See your sales outlet/Web site for specific vehicle application recommendations before installation. The Selection List/Undercarriage Selection Guide has specific vehicle and snowplow requirements.

SAFETY DEFINITIONS

⚠ WARNING
 Indicates a potentially hazardous situation that, if not avoided, could result in death or serious personal injury.

⚠ CAUTION
 Indicates a potentially hazardous situation that, if not avoided, may result in minor or moderate injury. It may also be used to alert against unsafe practices.

NOTE: Indicates a situation or action that can lead to damage to your snowplow and vehicle or other property. Other useful information can also be described.

WARNING/CAUTION & INSTRUCTION LABELS

Become familiar with and inform users about the warning and instruction labels on the back of the blade.

NOTE: If labels are missing or cannot be read, see your sales outlet.

Warning/Caution Label

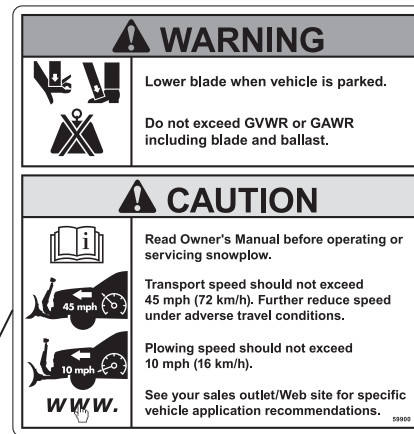

Instruction Label

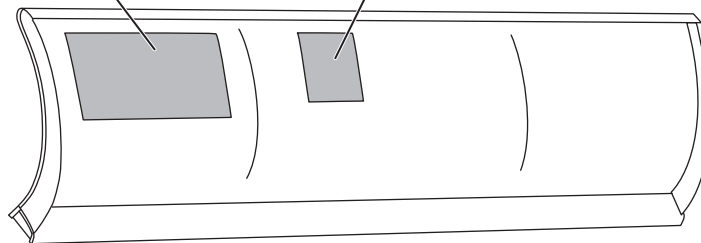

SAFETY PRECAUTIONS

Improper installation and operation could cause personal injury and/or equipment and property damage. Read and understand labels and the Owner's Manual before installing, operating or making adjustments.

⚠ WARNING

Lower the blade when vehicle is parked. Temperature changes could change hydraulic pressure, causing the blade to drop unexpectedly or damaging hydraulic components. Failure to do this could result in serious personal injury.

⚠ WARNING

The driver shall keep bystanders clear of the blade when it is being raised, lowered or angled. Do not stand between the vehicle and the blade or within 8 feet of a moving blade. A moving or falling blade could cause personal injury.

⚠ WARNING

Keep hands and feet clear of the blade and A-frame when mounting or removing the snowplow. Moving or falling assemblies could cause personal injury.

⚠ WARNING

Do not exceed GVWR or GAWR including the blade and ballast. The rating label is found on the driver-side vehicle door cornerpost.

⚠ WARNING

To prevent accidental movement of the blade, always turn the control OFF whenever the snowplow is not in use. The power indicator light will turn OFF.

⚠ WARNING

Remove blade assembly before placing vehicle on hoist.

⚠ CAUTION

Refer to the Selection List/Undercarriage Selection Guide for minimum vehicle recommendations and ballast requirements.

PERSONAL SAFETY

- Remove ignition key and put the vehicle in park or in gear to prevent others from starting the vehicle during installation or service.
- Wear only snug-fitting clothing while working on your vehicle or snowplow.
- Do not wear jewelry or a necktie, and secure long hair.
- Wear safety goggles to protect your eyes from battery acid, gasoline, dirt and dust.
- Avoid touching hot surfaces such as the engine, radiator, hoses and exhaust pipes.
- Always have a fire extinguisher rated BC handy, for flammable liquids and electrical fires.

FIRE AND EXPLOSION

⚠ WARNING

Gasoline is highly flammable and gasoline vapor is explosive. Never smoke while working on vehicle. Keep all open flames away from gasoline tank and lines. Wipe up any spilled gasoline immediately.

Be careful when using gasoline. Do not use gasoline to clean parts. Store only in approved containers away from sources of heat or flame.

CELL PHONES

A driver's first responsibility is the safe operation of the vehicle. The most important thing you can do to prevent a crash is to avoid distractions and pay attention to the road. Wait until it is safe to operate Mobile Communication Equipment such as cell phones, text messaging devices, pagers or two-way radios.

VENTILATION

⚠ WARNING

Vehicle exhaust contains lethal fumes. Breathing these fumes, even in low concentrations, can cause death. Never operate a vehicle in an enclosed area without venting exhaust to the outside.

NOISE

Airborne noise emission during use is below 70 dB(A) for the snowplow operator.









VIBRATION

Operating snowplow vibration does not exceed 2.5 m/s² to the hand-arm or 0.5 m/s² to the whole body.

TORQUE CHART

⚠ CAUTION

Read instructions before assembling. Fasteners should be finger tight until instructed to tighten according to the torque chart. Use standard methods and practices when attaching snowplow, including proper personal protective safety equipment.

Recommended Fastener Torque Chart					
Inch Fasteners Grade 5 and Grade 8					
Size	Torque (ft-lb)		Size	Torque (ft-lb)	
	 Grade 5	 Grade 8		 Grade 5	 Grade 8
1/4-20	8.4	11.9	9/16-12	109	154
1/4-28	9.7	13.7	9/16-18	121	171
5/16-18	17.4	24.6	5/8-11	150	212
5/16-24	19.2	27.3	5/8-18	170	240
3/8-16	30.8	43.6	3/4-10	269	376
3/8-24	35.0	49.4	3/4-16	297	420
7/16-14	49.4	69.8	7/8-9	429	606
7/16-20	55.2	77.9	7/8-14	474	669
1/2-13	75.3	106.4	1-8	644	909
1/2-20	85.0	120.0	1-12	704	995
Metric Fasteners Class 8.8 and 10.9					
Size	Torque (ft-lb)		Size	Torque (ft-lb)	
	 Class 8.8	 Class 10.9		 Class 8.8	 Class 10.9
M6 x 1.00	7.7	11.1	M20 x 2.50	325	450
M8 x 1.25	19.5	26.9	M22 x 2.50	428	613
M10 x 1.50	38.5	53.3	M24 x 3.00	562	778
M12 x 1.75	67	93	M27 x 3.00	796	1139
M14 x 2.00	107	148	M30 x 3.50	1117	1545
M16 x 2.00	167	231	M33 x 3.50	1468	2101
M18 x 2.50	222	318	M36 x 4.00	1952	2701
These torque values apply to fasteners except those noted in the instructions.					

INSTALLATION INSTRUCTIONS

NOTE: For easier assembly and installation, vehicle and all snowplow components should be on a smooth, level, hard surface, such as concrete.

1. Remove the bumper by unbolting it at the frame. Retain the fasteners.
2. Push the passenger-side mount tight up against the bottom of the frame. Then move the mount forward until the front edge of the mount upright is approximately 2-1/4" from the back of the bumper plate. Clamp the mount into place against the frame.

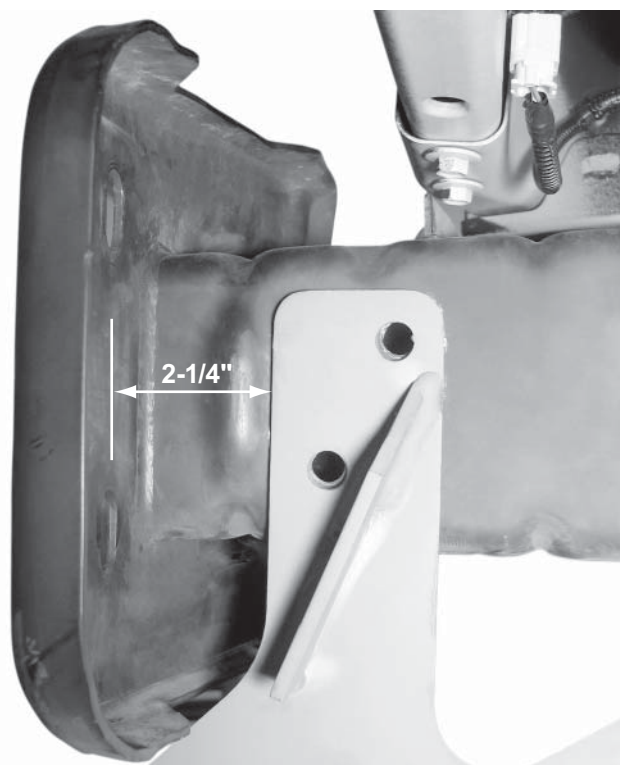

⚠ CAUTION

Use caution not to pinch, cut or drill through any wires or hoses running along the frame rails.

3. Using the holes in the mount as guides, drill four 17/32" holes through the inner wall of the frame.

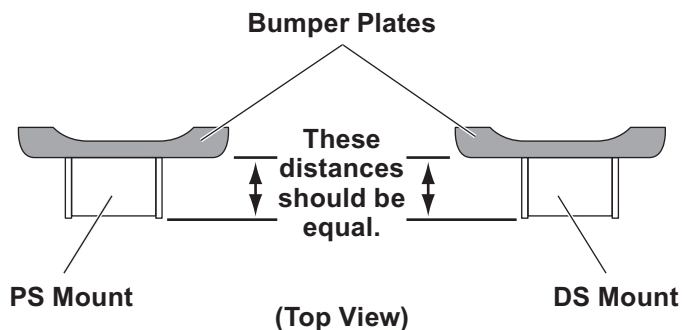
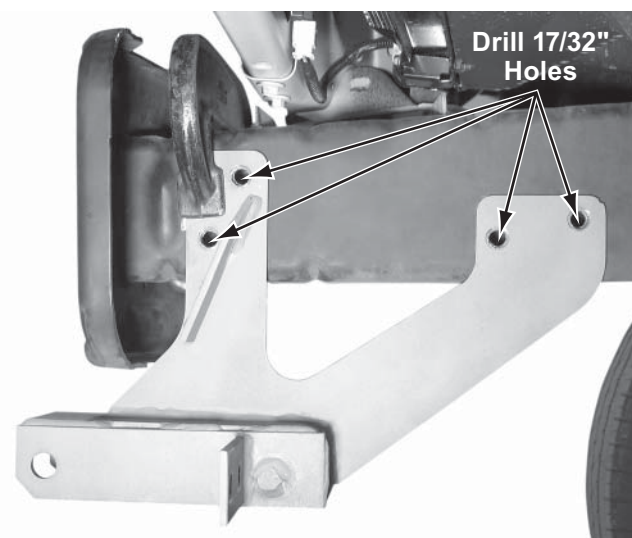

4. Insert two 1/2" x 1-1/2" cap screws with handles and 1/2" flat washers into the inside of the truck frame and out through the rear drilled holes. Attach a 1/2" locknut to each cap screw and hand tighten.
5. Insert two 1/2" x 1-1/2" cap screws and 1/2" flat washers into the inside of the truck frame and out through the front drilled holes. Attach a 1/2" locknut to each cap screw and hand tighten.
6. Bend or cut the ends of the cap screw handles protruding out from the truck frame to allow for proper bumper attachment.

7. Repeat Steps 2–6 for the driver-side mount, making sure before drilling that both U-brackets are the same distance away from the front of the bumper plates.
8. Install the cross bar using four 1/2" x 1-1/2" cap screws and 1/2" locknuts. Hand tighten the fasteners.
9. Check for a U-bracket distance of 30-7/16" ± 1/8". Take a second measurement farther back on the mounts to ensure that they are parallel. If U-bracket distance is not within 30-7/16" ± 1/8", then 1/2" flat washers may be used to shim one or both mounts in the appropriate direction to obtain the desired dimension. Tighten all fasteners according to the torque chart after achieving the appropriate dimensions.

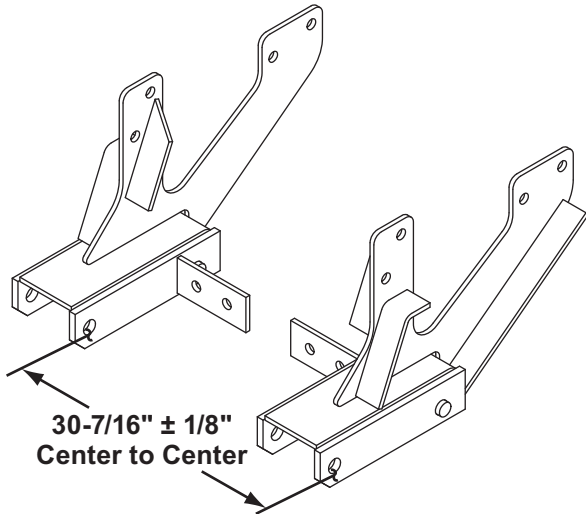

10. Remove or notch the air dam to allow sufficient clearance for the U-brackets and mounting of the blade assembly. See below for the suggested modification.

NOTE: Only cut air dam notches high enough to clear the U-brackets. The air dam should remain as one piece.

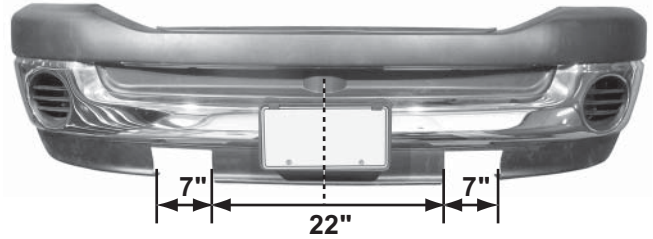

11. Reattach the bumper using the original fasteners.

NOTE: After five to ten hours of snowplow usage, retorque all mount assembly fasteners.

The company reserves the right under its product improvement policy to change construction or design details and furnish equipment when so altered without reference to illustrations or specifications used. This equipment manufacturer or the vehicle manufacturer may require or recommend optional equipment for snow removal. Do not exceed vehicle ratings with a snowplow. The company offers a limited warranty for all snowplows and accessories. See separately printed page for this important information.